



Design Example Report

Title	<i>65 W High Power Factor Isolated Flyback with Switched Valley Fill PFC Power Supply using LYTSwitch™-6 PowiGaN™ LYT6079C</i>
Specification	90 VAC – 132 VAC Input; 24 V, 2.7 A Output
Application	LED Lighting
Author	Applications Engineering Department
Document Number	DER-857
Date	November 11, 2019
Revision	1.0

Summary and Features

- Accurate constant voltage and constant current regulation
- Industry first AC/DC controller with isolated, safety rated feedback without optocoupler
- High power factor, >0.9 at 120 VAC
- Ultrafast transient response
- Highly energy efficient, >88 % across line
- Integrated protection and reliability features
 - Output short-circuit protection
 - Line and output OVP
 - Thermal foldback and over temperature shutdown with hysteretic automatic power recovery
- CCM + quasi-resonant switching for precision CC/CV operation without need for loop compensation
- Meets IEC 2.5 kV ring wave, 1 kV differential surge
- Meets EN55022 conducted EMI

PATENT INFORMATION

The products and applications illustrated herein (including transformer construction and circuits external to the products) may be covered by one or more U.S. and foreign patents, or potentially by pending U.S. and foreign patent applications assigned to Power Integrations. A complete list of Power Integrations' patents may be found at www.power.com. Power Integrations grants its customers a license under certain patent rights as set forth at <https://www.power.com/company/intellectual-property-licensing/>.

Power Integrations

5245 Hellyer Avenue, San Jose, CA 95138 USA.
Tel: +1 408 414 9200 Fax: +1 408 414 9201
www.power.com

Table of Contents

1	Introduction	4
2	Power Supply Specification	6
3	Schematic	7
4	Circuit Description	8
4.1	EMI Filter and Rectifier	8
4.2	Primary Circuit	8
4.3	LYTSwitch-6 Secondary-Side Control	9
4.4	PFC Circuit Operation	10
5	PCB Layout	11
6	Bill of Materials	12
6.1	Electricals	12
6.2	Mechanicals and Miscellaneous	13
7	PFC Inductor (T1) Specification	14
7.1	Electrical Diagram	14
7.2	Electrical Specifications	14
7.3	Material List	14
7.4	Inductor Build Diagram	15
7.5	Inductor Construction	15
7.6	Inductor Winding Illustrations	16
8	Transformer (T2) Specifications	19
8.1	Electrical Diagram	19
8.2	Electrical Specifications	19
8.3	Material List	19
8.4	Transformer Build Diagram	20
8.5	Transformer Construction	20
8.6	Transformer Winding Illustrations	21
9	Design Spreadsheet	25
10	Performance Data	27
10.1	Output Voltage Regulation	27
10.2	System Efficiency	28
10.3	Power Factor	29
10.4	%ATHD	30
10.5	No-Load Input Power	31
10.6	Output Voltage Regulation vs. Load	32
10.7	Efficiency vs. Load	33
11	Test Data	34
11.1	Test Data at Full Load	34
11.2	Test Data at No-Load	34
11.3	Test Data at different Loads	35
11.3.1	90 VAC Input	35
11.3.2	120 VAC Input	36
11.3.3	132 VAC Input	37
12	Thermal Performance	38



12.1	Thermal Measurements at Ambient Room Temperature	38
12.2	Thermal Performance at High Ambient Temperature.....	41
13	Waveforms	43
13.1	Input Voltage and Input Current at Full Load.....	43
13.2	Start-up Profile at Full Load	44
13.3	Turn-Off Profile at Full Load	45
13.4	LYTSwitch-6 Drain Voltage and Current Waveforms at Normal Operation	46
13.5	LYTSwitch-6 Drain Voltage and Current at Full Load Start-up	48
13.6	LYTSwitch-6 Drain Voltage and Current during Output Short-Circuit.....	50
13.7	Input Power during Output Short-Circuit	52
13.8	PFC Diode Voltage and Current at Normal Operation.....	53
13.9	PFC Diode Voltage and Current at Start-up Full Load	54
13.10	SR-FET Voltage	55
13.11	Output Current Ripple.....	57
13.11.1	Ripple Measurement Techniques.....	57
13.11.2	Output Voltage Ripple Waveforms	58
14	Conducted EMI	59
14.1	Test Set-up	59
14.1.1	Equipment and Load Used	59
14.2	EMI Test Result	60
14.2.1	Earthed Conducted EMI.....	60
15	Line Surge.....	62
15.1	Differential Surge Test Results.....	62
15.2	Ring Wave Surge Test Results	62
16	Revision History	63

Important Note: Although this board is designed to satisfy safety isolation requirements, the engineering prototype has not been agency approved. Therefore, all testing should be performed using an isolation transformer to provide the AC input to the prototype board.

1 Introduction

This engineering report describes an isolated flyback LED driver. It is designed to drive a nominal LED voltage string of 24 V at 2.7 A through a constant current post regulator from an input voltage range of 90 VAC to 132 VAC. The LED driver utilizes the LYT6079C from the LYTSwitch-6 family of devices, which has a higher current limit than the usual LYT6079C part.

DER-857 is a low-line input flyback converter design added with a switched valley-fill PFC circuit. Through the PFC circuit, the design meets the high power factor requirement in LED lighting application while reducing loss by direct energy transfer. The key design goals were high efficiency and high power factor across the input voltage range.

This document contains the power supply specification, schematic diagram, bill of materials, transformer documentation, printed circuit board layout, and performance data.

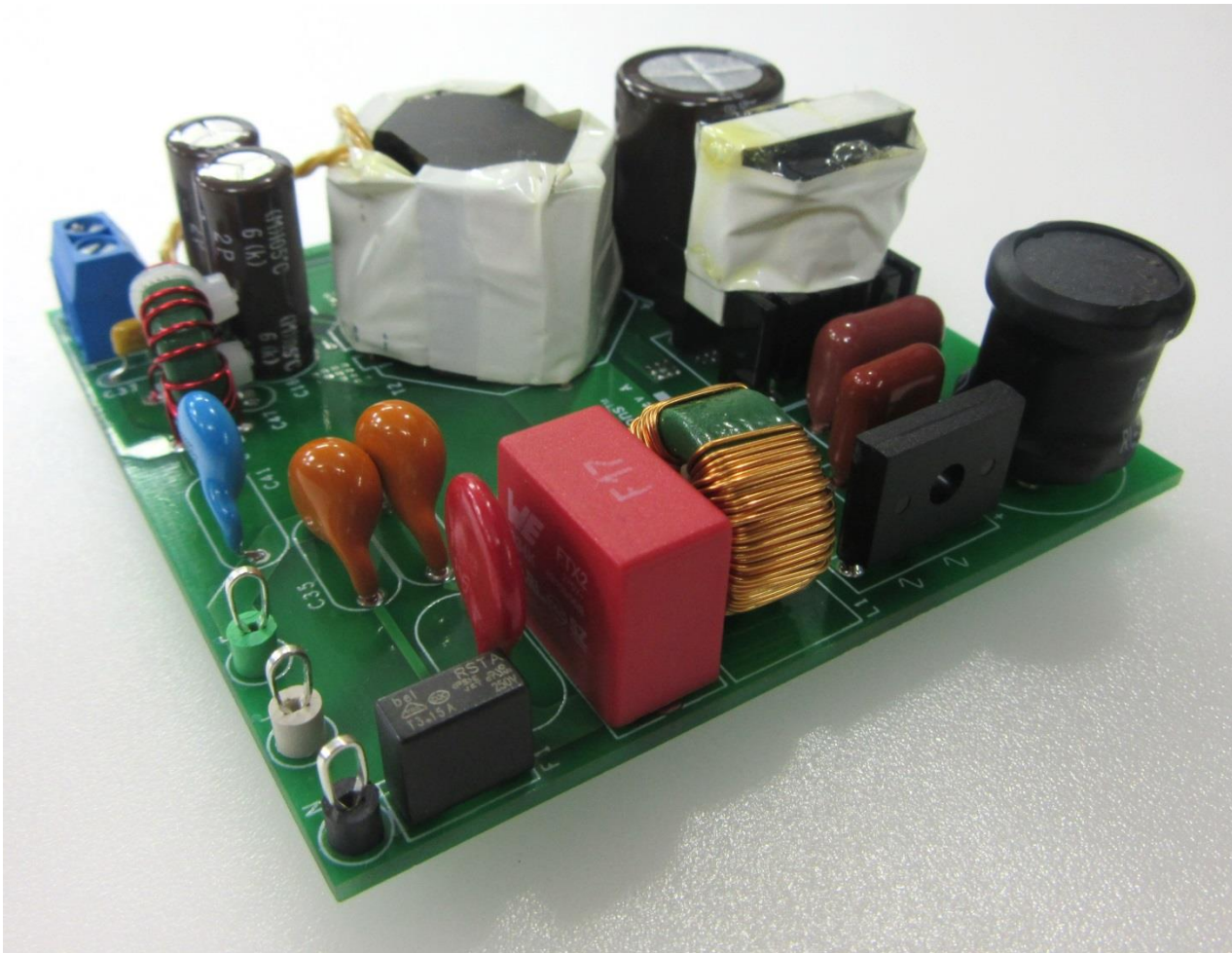

Figure 1 – Populated Circuit Board.



Figure 2 – Populated Circuit Board, Top View.

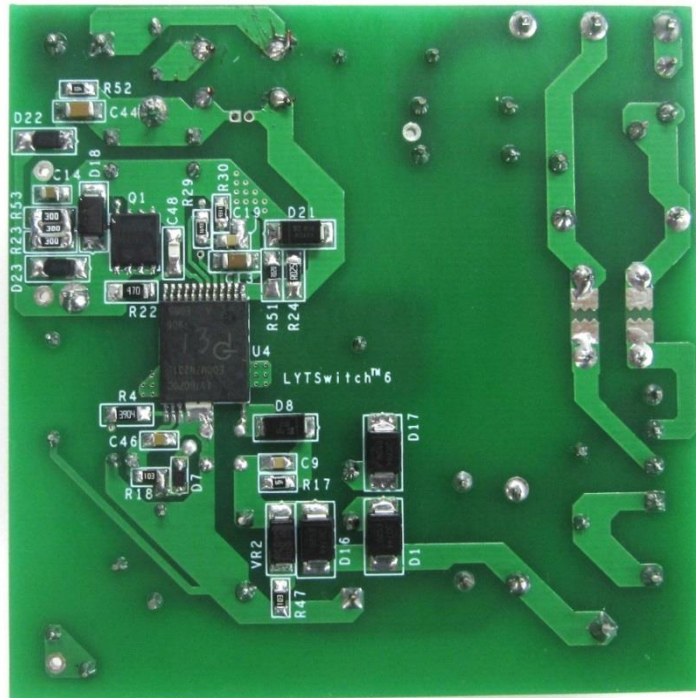

Figure 3 – Populated Circuit Board, Bottom View.

2 Power Supply Specification

The table below represents the minimum acceptable performance of the design. Actual performance is listed in the results section.

Description	Symbol	Min	Typ	Max	Units	Comment
Input Voltage Frequency	V_{IN} f_{LINE}	90	120 60	132	Vac/Hz	2 Wire – No P.E.
Output Output Voltage Output Current Total Output Power Continuous Output Power	V_{OUT} I_{OUT} P_{OUT}		24 2.7 65		V A W	CC Threshold: >2.7 A, Designed for 2.7 A CC Load.
Efficiency Full Load	η		90		%	At 120 VAC / 60 Hz. 25 °C Ambient Temperature.
Environmental Conducted EMI Safety Ring Wave (100 kHz) Differential Mode (L1-L2)						
			CISPR 15B / EN55015B Isolated			
			2.5		kV	
			1		kV	
Power Factor			0.9			Measured at 120 VAC / 60 Hz.
Ambient Temperature	T_{AMB}			50	°C	Free Air Convection, Sea Level. At 90 VAC Input.

3 Schematic

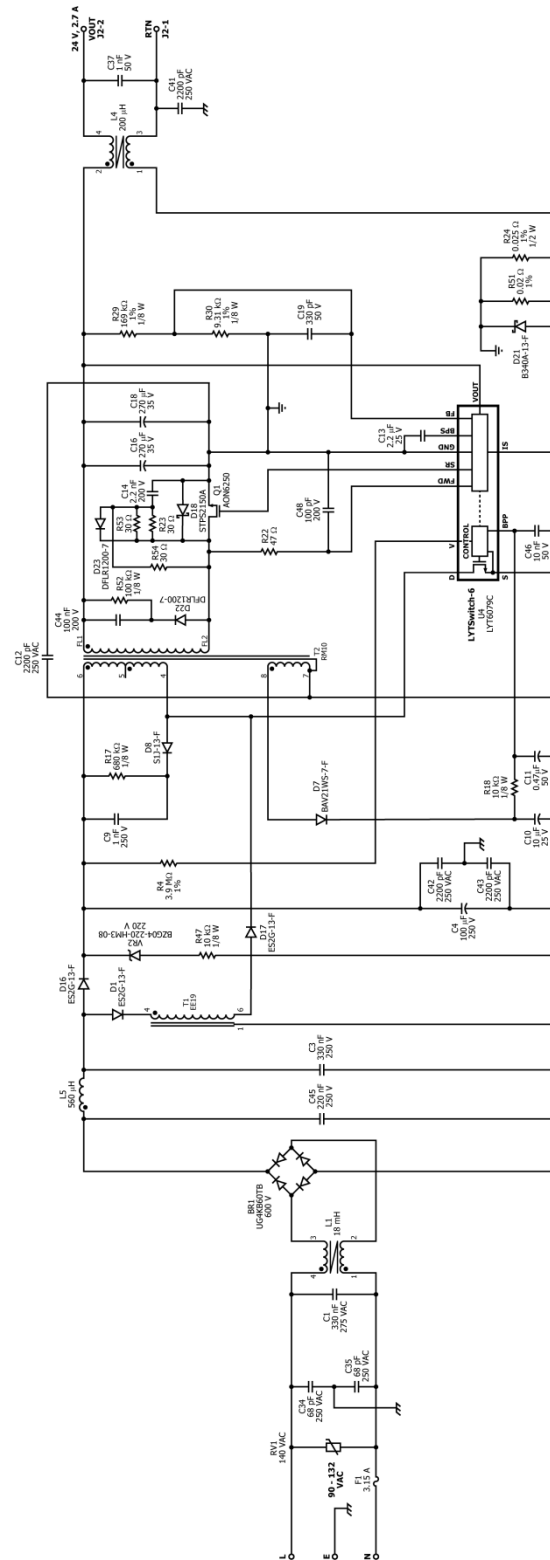

Figure 4 – Schematic.



4 Circuit Description

The LYTSwitch-6 device (LYT6079C) integrates a 725 V power MOSFET with sense elements, a safety-rated feedback mechanism, and includes both primary-side and secondary-side controllers in one device. The LYTSwitch-6 ICs use an integrated communication link, FluxLink™, for accurate control of the secondary-side by the primary-side and efficient utilization of close component proximity. The LYTSwitch-6 IC is designed to power a highly efficient 65 W flyback power supply with a switched valley-fill PFC providing high power factor for a 24 V constant voltage output throughout the input range of 90 VAC to 132 VAC. A constant current post regulator will regulate the output current at 2.7 A. Considering this, the designed constant current threshold of the power supply is set higher than the required 2.7 A.

4.1 EMI Filter and Rectifier

Fuse F1 provides protection from component failures. Varistor RV1 acts as a voltage clamp in case of voltage spikes from transient line surge. Bridge rectifier BR1 rectifies the AC line voltage and provides a full wave rectified DC across the input capacitors C45 and C3. Capacitor C1, C45, and C3 together with inductors L1 and L5 forms a 2-stage LC EMI filter to suppress differential and common mode noise caused by the PFC and flyback switching action. Y-capacitors C34 and C35 are added to further filter common mode noise.

The bulk capacitor C4 filters the input line voltage ripple for a stable DC supply voltage to the flyback converter. It also helps reduce EMI noise and stores the excess energy generated by the PFC during the power switch turn off time.

Rectifier diode (D16) delivers the charging current to C4 from the input rectified voltage. During FET off time, D16 blocks current from PFC supply so that flyback DC supply is isolated.

4.2 Primary Circuit

The DC-DC transformer T2 primary is connected across the positive output terminal of the bulk capacitor C4 and the drain of the integrated 725 V power MOSFET inside the LYTSwitch-6 IC U4.

An RCD snubber clamp formed by D8, R17, and C9 provides a low cost solution to limiting the voltage spike across the MOSFET in U4. This voltage spike is primarily caused by the energy stored in the leakage inductance of transformer T2.

The VOLTAGE MONITOR (V) pin of the LYTSwitch-6 IC is connected before the diode D16 to provide input voltage information. Sensing across the bulk capacitor C4 is prone to false line OVP triggering due to bulk voltage boosting. Due to this, sensing is done at D16 through the current across R4. The V pin detects line overvoltage for protection. The I_{OV} determines the input overvoltage threshold.

During start up, the LYTSwitch-6 IC is powered through the DRAIN (D) pin via an internal high voltage current source that charges the BPP pin capacitors C11 and C46. Once it is powered up, primary-side assumes control first and requires a handshake to pass the control to the secondary-side. This will go on for around 82 ms before the IC goes on an auto-restart sequence if the handshaking process is not completed. During normal operation the primary-side block is powered from an auxiliary winding on the transformer. The output of this is configured as a flyback winding which is rectified and filtered using diode D7 and capacitor C10. Resistor R18 sets the limit on the current being supplied to the BPP pin of the LYTSwitch-6 (U4). The 0.47 μF capacitance value for C11 corresponds to standard current limit mode.

A thermal shutdown feature is included in the LYTSwitch-6 IC. The thermal shutdown circuitry senses the primary MOSFET die temperature. The threshold (T_{SD}) is typically set to 142 $^{\circ}\text{C}$ with 70 $^{\circ}\text{C}$ hysteresis $T_{SD(H)}$. When the die temperature rises above this threshold the power MOSFET is disabled and remains disabled until the die temperature falls by $T_{SD(H)}$ at which point it is re-enabled. A large hysteresis of 70 $^{\circ}\text{C}$ is provided to prevent over-heating of the PCB due to continuous fault condition.

4.3 ***LYTSwitch-6 Secondary-Side Control***

The secondary side control of the LYTSwitch-6 IC provides output voltage sensing, output current sensing, and a gate drive for a MOSFET providing synchronous rectification. The secondary of the transformer is rectified by a synchronous rectifier MOSFET Q1, driven by the Synchronous Rectifier Drive (SR) pin of the LYTSwitch-6 IC. This is then filtered by the output capacitors C16 and C18. A Schottky diode D18 parallel to SR FET is added to increase efficiency. Since the designed power is high for an SVF $S^2\text{PFC}$ Flyback, two sets of snubbers are used to mitigate the voltage stress across Q1 and the FORWARD (FWD) pin. First, another RCD snubber, composed of D22, C44, and R52, is used across the secondary winding. Second, an RC snubber composed of C14 and the parallel combination of resistors R23, R53, and R54 is used. D23 is placed to further lessen the voltage stress and improve the thermals of the snubber resistor. Since the output is 24 V, the OUTPUT VOLTAGE (VO) pin is directly tapped onto the output which, along with the FORWARD (FWD) pin, powers the secondary side of the IC.

Since this power supply is designed to drive a constant current post regulator, it is designed to be operating at constant voltage mode. During constant voltage mode operation, output voltage regulation is achieved through sensing the output voltage via divider resistors R29 and R30. The voltage across R30 is fed into the FEEDBACK (FB) pin with an internal reference voltage threshold of 1.265 V. Filter capacitor C19 is added across R30 to eliminate unwanted noise that might trigger the OVP function or increase the output ripple voltage.

During constant current operation, the output current is set by the sense resistors R51 and R24 across the IS pin and the GND pin. The internal reference threshold for the IS pin is 35.8 mV. The resistors were chosen such that the constant current threshold is

above the designed output current of 2.7 A. A Schottky diode D21 in parallel with the current sense resistor serves as protection for IS pin during output short-circuit conditions.

Besides the thermal shutdown feature, the LYTSwitch-6 IC also has a thermal foldback feature. The thermal foldback is activated when the secondary controller die temperature reaches 124 °C. The output power is reduced by setting the constant current reference threshold to 60% of the original.

4.4 ***PFC Circuit Operation***

Without the added PFC circuit, the power factor of the flyback power supply is normally around 0.5 to 0.6 at full load condition. Input from the bridge rectifier (BR1) will just directly feed the bulk capacitor (C4) that charges and recharges till the next voltage peak fed to it. The input charging pulse current must be high enough to sustain the load until the next peak. This means that the charging pulse current is around 5-10 times higher than the average current with a high phase angle difference from the voltage waveform; hence, the expected PF from this standard configuration is low and THD is high.

The added PFC circuit is called "Switched Valley-Fill Single Stage PFC" (SVF S²PFC). It is composed of an inductor (T1) and diodes (D1 and D17) connected directly to the DRAIN (D) pin of the LYTSwitch-6 IC. Through this, the LYTSwitch-6 IC flyback switching action is able to draw a high frequency pulse current from the full wave rectified input. This will reduce the rms input current and the phase angle difference from the input line voltage will be lower; hence, power factor will increase and will improve THD.

The PFC inductor T1 operates in DCM mode. At turn ON time of the LYTSwitch-6 IC, current delivered by the rectified input is stored in the PFC inductor which is then delivered via direct energy transfer to the flyback transformer T2. Excess energy from the PFC inductor that is not delivered to the load is being stored to the bulk capacitor. During no-load and light load conditions, the secondary requires less energy from the primary; therefore, more excess energy from the PFC inductor is stored on the bulk capacitor C4 causing the voltage to rise gradually which will be higher than that of the peak input. For this a Zener-resistor clamp (VR2, R47) was added in parallel with the bulk capacitor to limit the rise in voltage. The Zener voltage is set at 220 V; when the bulk voltage goes beyond this, the Zener diode conducts and bleeds current from the bulk capacitor through resistor R47. This prevents the bulk capacitor voltage to rise above its rating 250 V. The power dissipation of this Zener-resistor clamp should be considered at the worst-case creeping of the bulk voltage – happens usually at light load condition. Diodes D1 and D17 are connected in series to withstand voltage stress caused by the resonance ringing during the FET turn off. The variability of the PFC inductor peak current will be compensated by the LYTSwitch-6 IC primary and secondary-side control maintaining the voltage regulation at all conditions.

5 PCB Layout

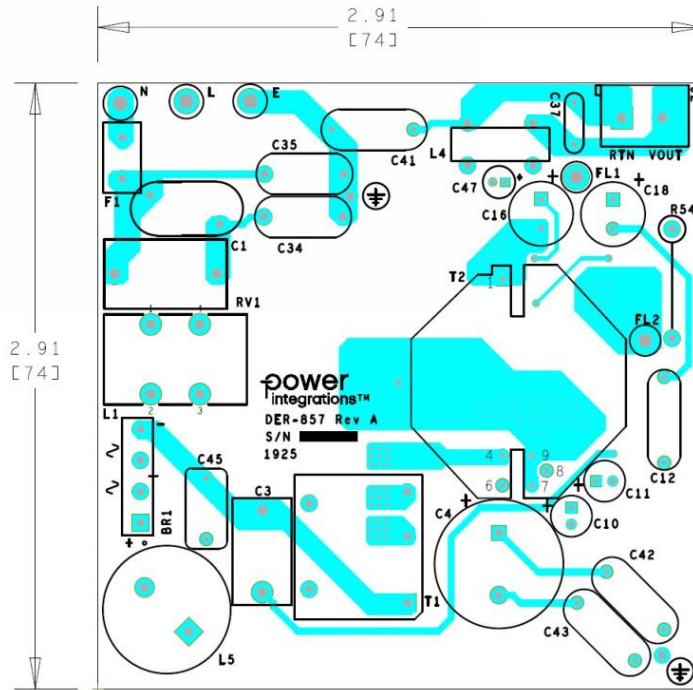

Figure 5 – Main Board Top Side.

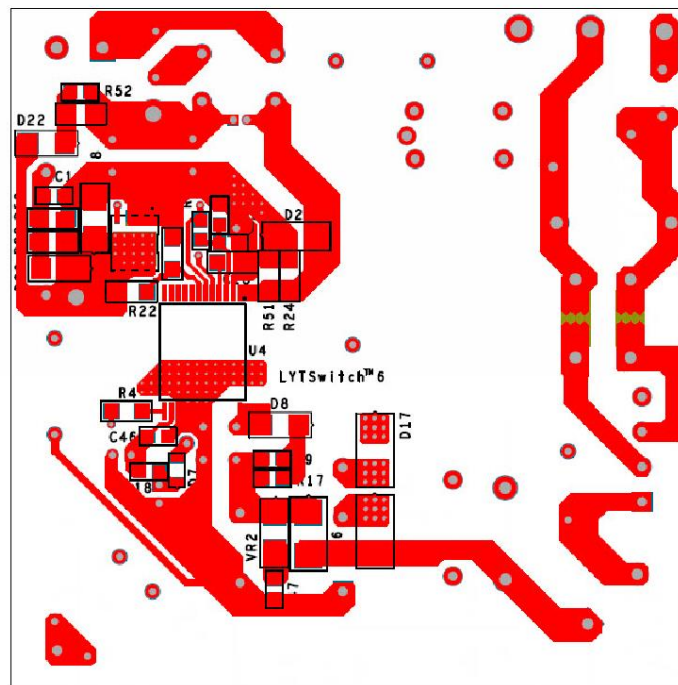

Figure 6 – Main Board Bottom Side.

6 Bill of Materials

6.1 *Electricals*

Item	Qty	Ref Des	Description	Mfg. Part Number	Mfg.
1	1	BR1	Bridge Rectifier, 600 V, 4 A, -55°C ~ 150°C (TJ), 1.1V @ 4A, 4-ESIP, D3K	UG4KB60TB	SMC Diode Solutions
2	1	C1	330 nF, ±10%, 275 VAC, Polypropylene Film, X2, 15.00 mm x 8.50 mm	890324024003CS	Wurth
3	1	C3	330 nF, 250 V, 5%, Polypropylene Metalized	ECW-F2334JAQ	Panasonic
4	1	C4	100 µF, ±20%, 250 V, Electrolytic, 12000 Hrs @ 105°C (16 x 21.5)	UCY2E101MHD	Nichicon
5	1	C9	1 nF, 250 V, Ceramic, X7R, 0805	GRM21AR72E102KW01D CS0805KRX7RYBB102	Murata Yageo
6	1	C10	10 µF, 25 V, Electrolytic, Gen. Purpose, (5 x 12)	ECA-1EM100	Panasonic
7	1	C11	0.47 µF, ±20%, 50 V, Electrolytic, (5 x 12.5), LS 2 mm	860020672004	Wurth
8	1	C12	2200 pF, ±20%, 250 VAC, X1, Y1, Disc Ceramic	DE1E3KX222MN4AN01F	Murata
9	1	C13	2.2 µF, 25 V, Ceramic, X7R, 1206	TMK316B7225KL-T	Taiyo Yuden
10	1	C14	2.2 nF, 200 V, Ceramic, X7R, 0805	08052C222KAT2A	AVX
11	1	C16	270 µF, 35 V, Electrolytic, Very Low ESR, 41 mΩ, (8 x 20)	EKZE350ELL271MH20D	Nippon Chemi-Con
12	1	C18	270 µF, 35 V, Electrolytic, Very Low ESR, 41 mΩ, (8 x 20)	EKZE350ELL271MH20D	Nippon Chemi-Con
13	1	C19	330 pF, ±10%, 50 V, X7R, Ceramic, -55°C ~ 125°C, MLCC 0805	CL21B331KBANNNC	Samsung
14	1	C34	68 pF, Ceramic, Y1	440LQ68-R	Vishay
15	1	C35	68 pF, Ceramic, Y1	440LQ68-R	Vishay
16	1	C37	1 nF, 50 V, Ceramic, X7R	K102K15X7RF5TH5	Vishay
17	1	C41	2200 pF, ±20%, 250 VAC, X1, Y1, Disc Ceramic	DE1E3KX222MN4AN01F	Murata
18	1	C42	2200 pF, ±20%, 250 VAC, X1, Y1, Disc Ceramic	DE1E3KX222MN4AN01F	Murata
19	1	C43	2200 pF, ±20%, 250 VAC, X1, Y1, Disc Ceramic	DE1E3KX222MN4AN01F	Murata
20	1	C44	100 nF, 200 V, Ceramic, X7R, 1206	C1206C104K2RACTU	Kemet
21	1	C45	220 nF, 250V, 5%, Film	MEXID3220JJ	Duratech
22	1	C46	10 nF, 50 V, Ceramic, X7R, Automotive, AEC-Q200, 0805	C0805C103K5RACTU	Kemet
23	1	C48	100 pF, 200 V, Ceramic, COG, 0805	08052A101JAT2A	AVX
24	1	D1	400 V, 2 A, Super Fast, 35 ns, DO-214A, SMB	ES2G-13-F	Diodes, Inc.
25	1	D7	250 V, 0.2 A, Fast Switching, 50 ns, SOD-323	BAV21WS-7-F	Diodes, Inc.
26	1	D8	600 V, 1 A, Standard Recovery, SMA	S1J-13-F	Diodes, Inc.
27	1	D16	400 V, 2 A, Super Fast, 35 ns, DO-214A, SMB	ES2G-13-F	Diodes, Inc.
28	1	D17	400 V, 2 A, Super Fast, 35 ns, DO-214A, SMB	ES2G-13-F	Diodes, Inc.
29	1	D18	150 V, 2 A, Schottky, SMD, DO-214AA	STPS2150A	ST Micro
30	1	D21	DIODE, SCHOTTKY, 40V, 3A, SMA, DO-214AA	B340A-13-F	Diodes, Inc.
31	1	D22	200 V, 1 A, Rectifier, Glass Passivated, POWERDI123	DFLR1200-7	Diodes, Inc.
32	1	D23	200 V, 1 A, Rectifier, Glass Passivated, POWERDI123	DFLR1200-7	Diodes, Inc.
33	1	F1	3.15 A, 300V, Slow, Long Time Lag, RST	36913150000	Littlefuse
34	1	L1	Custom, CMC, 18 mH @ 10KHz, Toroidal, 17.5 mm OD x 11.0 mm thick. 40 turns x 2, 0.40mm wire 190 mΩ max	04291-T231	Sumida
35	1	L4	200 µH, Toroidal CMC, custom, DER-742, OUTPUT (L4), Wound on Toroid Core: PI #32-00315-00 (Bipolar Electronics TW GL50 T 12X6X4-C or equivalent)	32-00373-00	Power Integrations
36	1	L5	560 µH, 1.60 A, 20%	RL-5480-5-560	Renco
37	1	Q1	MOSFET, N-CH, 150V, 52A, 8DFN	AON6250	Alpha & Omega Semi
38	1	R4	RES, 3.9 MΩ, 1%, 1/4 W, Thick Film, 1206	RC1206FR-073M9L	Panasonic
39	1	R17	RES, 680 kΩ, 5%, 1/8 W, Automotive, AEC-Q200, Thick Film, 0805	ERJ-6GEYJ684V	Panasonic
40	1	R18	RES, 10 kΩ, 5%, 1/8 W, Automotive, AEC-Q200, Thick Film, 0805	ERJ-6GEYJ103V	Panasonic
41	1	R22	RES, 47 Ω, 5%, 1/4 W, Automotive, AEC-Q200, Thick Film, 1206	ERJ-8GEYJ470V	Panasonic
42	1	R23	RES, 30 Ω, 5%, 1/4 W, Automotive, AEC-Q200, Thick Film, 1206	ERJ-8GEYJ300V	Panasonic
43	1	R24	RES, 0.025 Ω, 1/2 W, 1%, Current Sense	CSR1206FK25L0	Stackpole



44	1	R29	RES, 169 k Ω , 1%, 1/8 W, Automotive, AEC-Q200, Thick Film, 0805	ERJ-6ENF1693V	Panasonic
45	1	R30	RES, 9.31 k Ω , 1%, 1/8 W, Automotive, AEC-Q200,Thick Film, 0805	ERJ-6ENF9311V	Panasonic
46	1	R47	RES, 10 k Ω , 5%, 1/8 W, Automotive, AEC-Q200,Thick Film, 0805	ERJ-6GEYJ103V	Panasonic
47	1	R51	RES, 0.02 Ω , 1%, 1/4 W, Thick Film, 0805	RL0805FR-7W0R02L	Yageo
48	1	R52	RES, 100 k Ω , 5%, 1/8 W, Automotive, AEC-Q200,Thick Film, 0805	ERJ-6GEYJ104V	Panasonic
49	1	R53	RES, 30 Ω , 5%, 1/4 W, Automotive, AEC-Q200,Thick Film, 1206	ERJ-8GEYJ300V	Panasonic
50	1	R54	RES, 30 Ω , 5%, 1/4 W, Automotive, AEC-Q200,Thick Film, 1206	ERJ-8GEYJ300V	Panasonic
51	1	RV1	140 VAC, 22 J, 10 mm, RADIAL	V140LA5P	Littlefuse
52	1	T1	Bobbin, EE19, Vertical, 10 pins, 6pri, 4sec	TF-1939	Taiwan Shulin
53	1	T2	Bobbin, RM10, Vertical, 12 pins	RM10	Alliance Magnetic
54	1	U4	LYTSwitch-6 Integrated Circuit, InSOP24D	LYT6079C-H129	Power Integrations
55	1	VR2	DIODE, ZENER, 220 V, 0.09 %/K, 50 A, 3 W, DO-214AC, SMA	BZG04-220-HM3-08	Vishay

6.2 *Mechanicals and Miscellaneous*

Item	Qty	Ref Des	Description	Mfg. Part Number	Mfg.
55	1	E	Test Point, GRN, THRU-HOLE MOUNT	5126	Keystone
56	1	J2	CONN TERM BLOCK, 2 POS, 5mm, PCB	ED500/2DS	On Shore Tech
57	1	JP1	Wire Jumper, Insulated, TFE, #22 AWG, 4.0 in	C2004-12-02	Alpha
58	1	L	Test Point, WHT, THRU-HOLE MOUNT	5012	Keystone
59	1	N	Test Point, BLK, THRU-HOLE MOUNT	5011	Keystone
60	1	SCREW1	SCREW MACHINE PHIL 6-32 X 3/8 SS	PMSSS 632 0038 PH	Building Fasteners
61	1	SCREW2	SCREW MACHINE PHIL 6-32 X 3/8 SS	PMSSS 632 0038 PH	Building Fasteners
62	1	SCREW3	SCREW MACHINE PHIL 6-32 X 3/8 SS	PMSSS 632 0038 PH	Building Fasteners

7 PFC Inductor (T1) Specification

7.1 Electrical Diagram

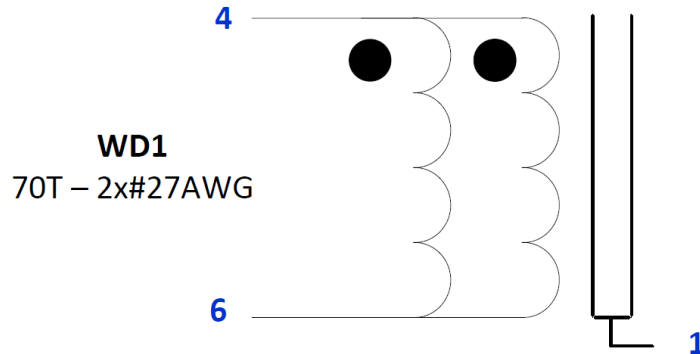

Figure 7 – Inductor Electrical Diagram.

7.2 Electrical Specifications

Parameter	Condition	Spec.
Nominal Primary Inductance	Measured at 1 V _{PK-PK} , 100 kHz switching frequency, between pin 4 and pin 6.	330 μ H
Tolerance	Tolerance of Primary Inductance.	\pm 5%

7.3 Material List

Item	Description
[1]	Core: EE19 3C90 or Equivalent.
[2]	Bobbin, EE19, Vertical, 10 Pins.
[3]	Magnet Wire: #27 AWG.
[4]	Polyester Tape: 9 mm.
[5]	Polyester Tape: 5 mm.
[6]	Polyester Tape: 7 mm.
[7]	Copper Tape: 4 mm.
[8]	Copper Tape: 6 mm.

7.4 **Inductor Build Diagram**

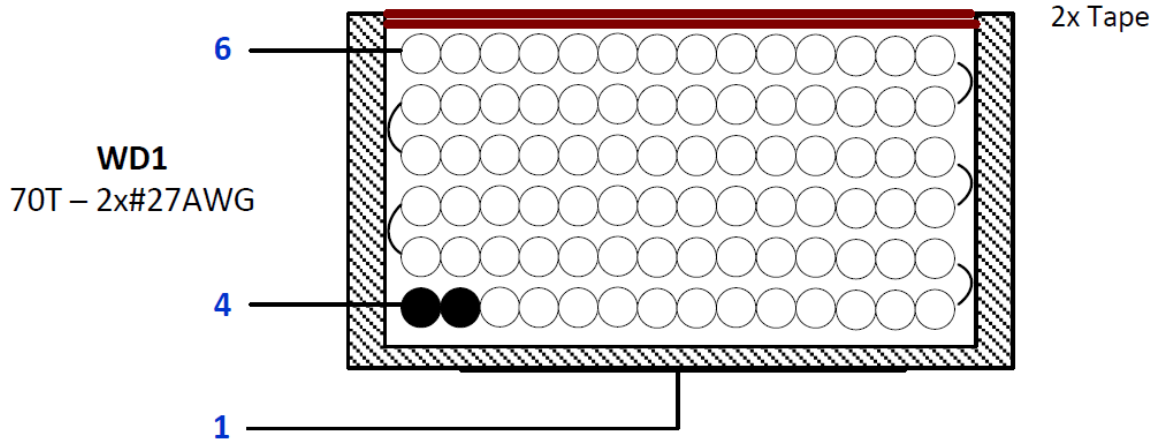
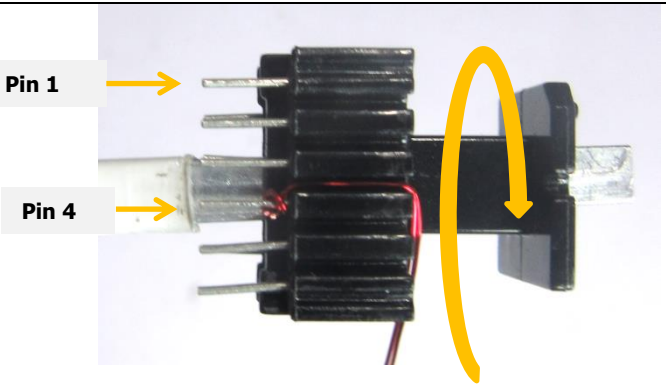
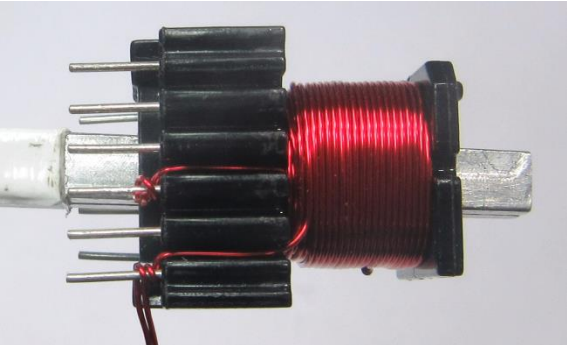
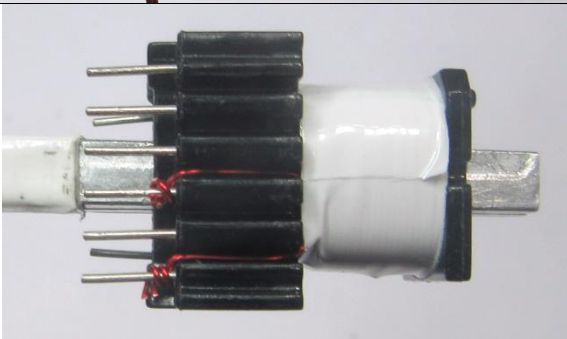
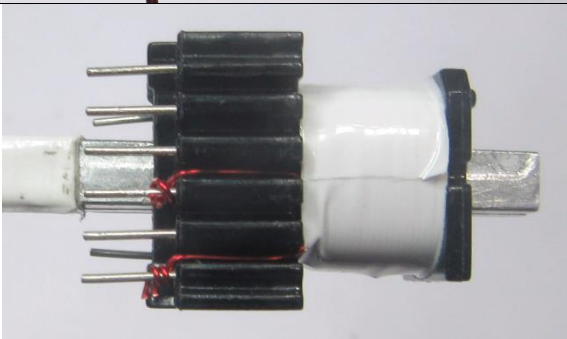

Figure 8 – Inductor Build Diagram.

7.5 **Inductor Construction**

Winding Directions	Bobbin is oriented on winder jig such that terminal pin 1-6 is on the left side. The winding direction is clockwise.
Winding 1	Use bifilar magnetic wire Item [3]. Start at pin 4 and wind 70 turns in multiple layers continuously. End at pin (6).
Insulation	Apply 2 layers of polyester tape, Item [4] for insulation.
Core Grinding	Grind the center leg of one core, Item [1], until it meets the nominal inductance of 330 μ H.
Core Termination	Place a small copper tape, Item [7], on the top side of the core and terminate it to pin 1 via a thin piece of wire.
Core Assembly	Use Item [5] to fix the cores into place and pull out pins 2, 3, 5, 8, and 9.
Belly Band	Apply one layer of Item [6] around the bobbin parallel to the winding. Wrap one layer of Item [8] directly on top of the layer of Item [6]. Ensure it does not touch the core. Apply another 2 layers of Item [6] on the copper tape for insulation.
Finish	Dip the transformer assembly in 2:1 varnish and thinner solution.

7.6 **Inductor Winding Illustrations**

<p>Winding Directions</p> <p>Bobbin is oriented on winder jig such that terminal pin 1-6 is on the left side. The winding direction is clockwise. Use bifilar magnetic wire Item [3] and start at pin 4.</p>	 
<p>Winding 1</p> <p>Wind 70 turns in multiple layers continuously. End at Pin 6.</p>	
<p>Insulation</p> <p>Apply 2 layers of polyester tape, Item [4] for insulation</p>	

Core Grinding and Termination

Grind the center leg of one core, Item [1], until it meets the nominal inductance of 330 μH .

Place a small copper tape, Item [7], on the top side of the core and terminate it to pin 1 via a thin piece of wire.

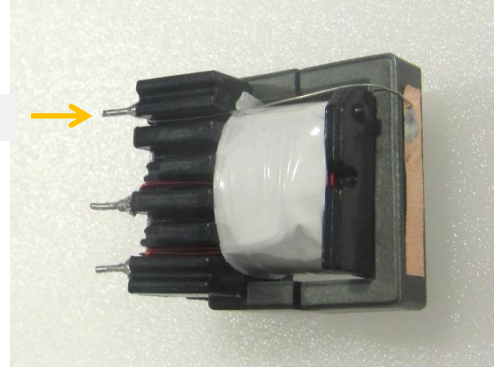
Pin 1**Core Assembly**

Use Item [5] to fix the cores into place and pull out pins 2, 3, 5, 8, and 9.

**Belly Band and Finish**

Apply one layer of Item [6] around the bobbin parallel to the winding.



Wrap one layer of Item [8] directly on top of the layer of Item [6]. Ensure it does not touch the core.



Apply another 2 layers of Item [6] on the copper tape for insulation. Dip the transformer in varnish.



8 Transformer (T2) Specifications

8.1 Electrical Diagram

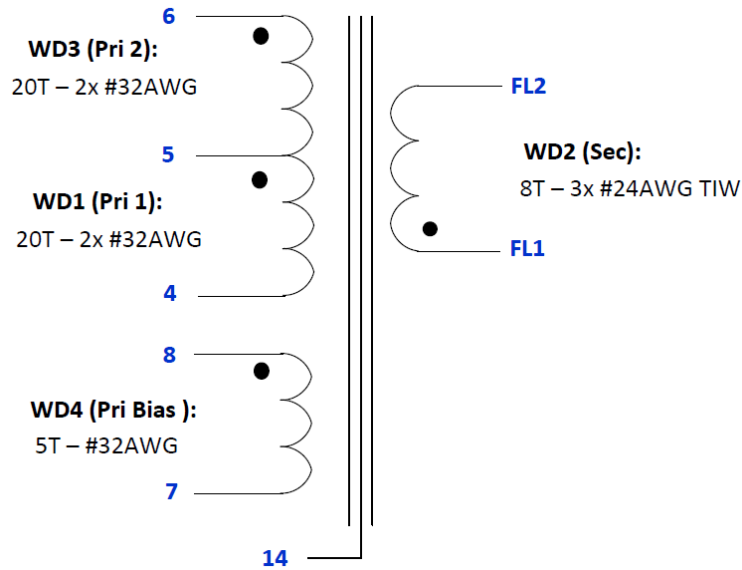

Figure 9 – Transformer Electrical Diagram.

8.2 Electrical Specifications

Parameter	Condition	Spec.
Nominal Primary Inductance	Measured at 1 V _{PK-PK} , 100 kHz switching frequency, between pin 4 and pin 6.	450 μH
Tolerance	Tolerance of Primary Inductance.	±7%
Leakage Inductance	Measured at 1 V _{PK-PK} , 100 kHz switching frequency, between pin 4 and pin 6 with all other windings shorted.	<5 μH

8.3 Material List

Item	Description
[1]	Core: RM10.
[2]	Bobbin: RM10, Vertical, 14 pins.
[3]	Core Clip: RM10.
[4]	Magnet Wire: #32 AWG.
[5]	Triple Insulated Wire: #24 AWG.
[6]	Polyester tape: 10.5 mm.
[7]	Polyester tape: 14 mm.
[8]	Polyester tape: 20 mm.

8.4 Transformer Build Diagram

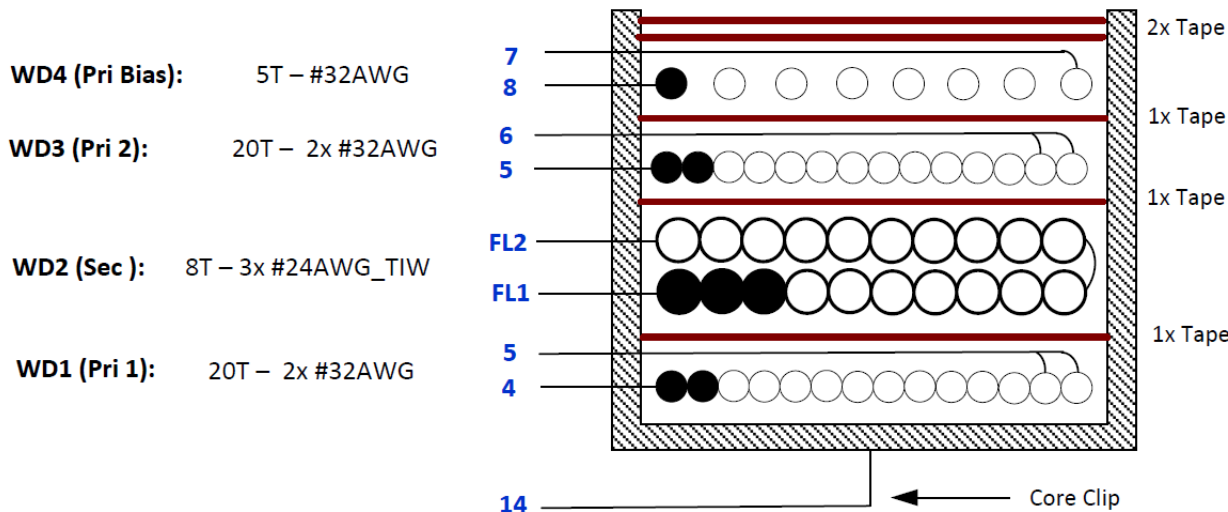

Figure 10 – Transformer Build Diagram.

8.5 Transformer Construction

Winding Directions	Bobbin is oriented on winder jig such that terminal pin 4 – 9 is on the left side. The winding direction is clockwise.
Winding 1	Prepare the magnetic wire Item [4], bifilar, for winding. Start at pin 4 and wind 20 turns in 1 layer. Terminate the winding on pin 5.
Insulation	Add 1 layer of tape, Item [6], for insulation.
Winding 2	Use Item [5], trifilar, and start winding from the notch on top of the bobbin. Wind 8 turns in 2 layers and end at the same notch.
Insulation	Add 1 layer of tape, Item [6], for insulation.
Winding 3	Use Item [4], bifilar, start at pin 5 and wind across the bobbin width up to 20 turns. Terminate at pin 6.
Insulation	Add 1 layer of tape, Item [6], for insulation.
Winding 4	Use Item [4], start at pin 8 and wind 5 turns evenly distributed across the bobbin. Terminate at pin 7.
Insulation	Add 2 layers of tape, Item [6], for insulation.
Core Grinding	Grind the center leg of the ferrite core Item [1] evenly until it meets the nominal inductance of 450 μ H. Inductance is measured across pin 4 and pin 6.
Assemble Core	Assemble the 2 cores on the bobbin.
Core Termination	Using Item [3], secure the cores in place. Pull out pins 2, 3, 9, 10, 11, 12, and cut pins 5, and 13
Core Tape	Using Item [8], wrap the bobbin with at least 2 layers perpendicular to the winding. Also, using Item [7], wrap the bobbin with 2 layers parallel to the winding.
Finish	Dip the transformer assembly in 2:1 varnish and thinner solution.

8.6 *Transformer Winding Illustrations*

Winding Directions

Bobbin is oriented on winder jig such that terminal pin 4 – 9 is on the left side. The winding direction is clockwise.

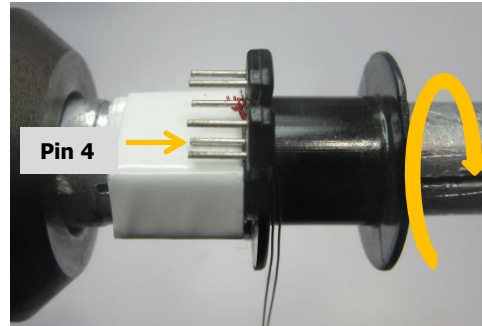

Winding 1

Prepare the magnetic wire Item [4], bifilar, for winding. Start at pin 4 and wind 20 turns in 1 layer. Terminate the winding on pin 5.

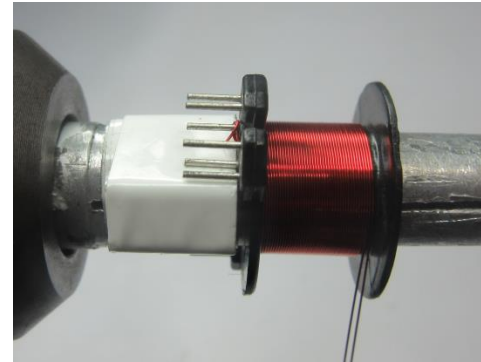

Insulation

Add 1 layer of tape, Item [6], for insulation

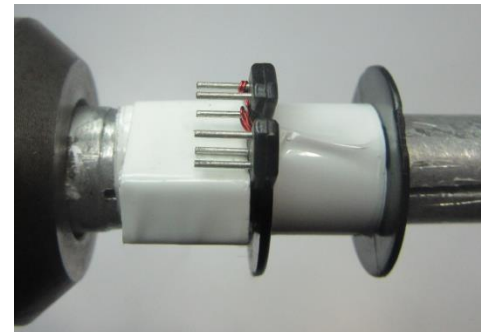

Winding 2

Use Item [5], trifilar, and start winding from the notch on top of the bobbin.



Wind 8 turns in 2 layers and end at the same notch.

Insulation

Add 1 layer of tape, Item [6], for insulation

Winding 3

Use Item [4], bifilar, start at pin 5 and wind across the bobbin width up to 20 turns. Terminate at pin 6.

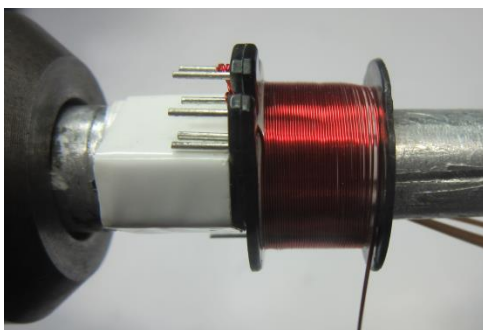
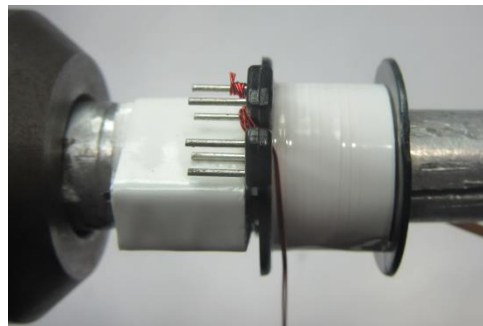
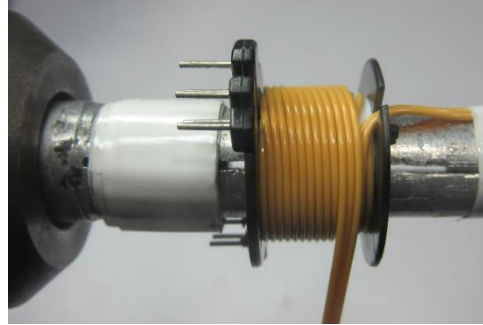

Insulation

Add 1 layer of tape, Item [6], for insulation

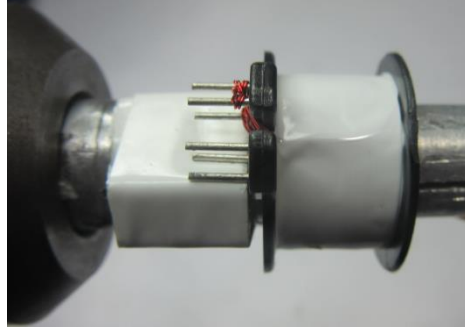
**Winding 4**

Use Item [4], start at pin 8 and wind 5 turns evenly distributed across the bobbin. Terminate at pin 7.

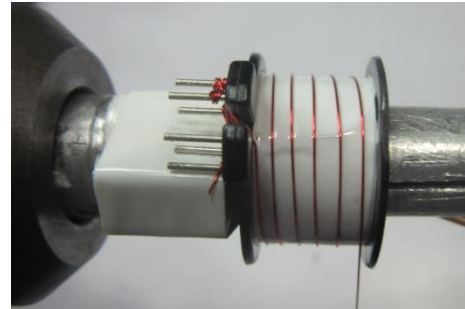
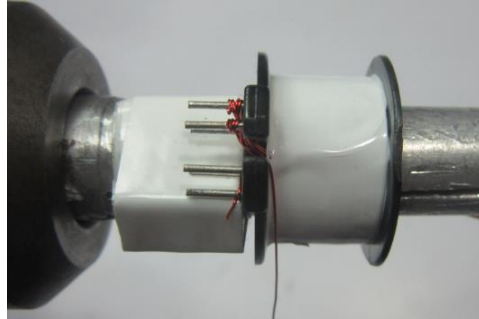
**Insulation**

Add 2 layers of tape, Item [6], for insulation.

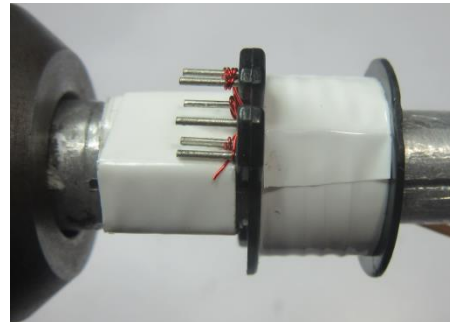

Core Grinding

Grind the center leg of the ferrite core Item [1] evenly until it meets the nominal inductance of 450 μ H. Inductance is measured across pin 4 and pin 6.

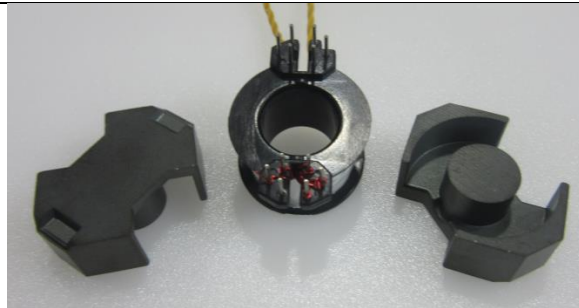
**Core Termination**

Using Item [3], secure the cores in place. Pull out pins 2, 3, 9, 10, 11, 12, and cut pins 5, and 13

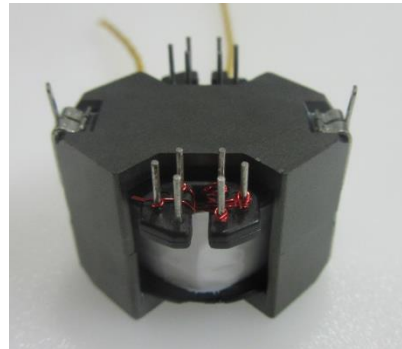
**Finish**

Using Item [8], wrap the bobbin with at least 2 layers perpendicular to the winding. Also, using Item [7], wrap the bobbin with 2 layers parallel to the winding. Dip the transformer assembly in 2:1 varnish and thinner solution.

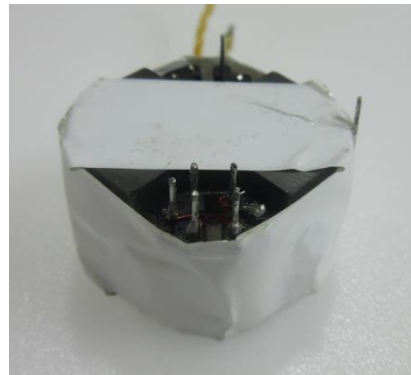

9 Design Spreadsheet

LYTSwitch-6 with Switched Valley Fill PFC	Output	Units	
INPUT SPECIFICATIONS			
VAC_min	90	V	Minimum input voltage
VAC_nom	120	V	Nominal input voltage
VAC_max	132	V	Maximum input voltage
FL	60	Hz	Line frequency
Cbulk	100	uF	Bulk capacitor
VO	24	V	Output Voltage
IO	2700	mA	Output Current
Efficiency	88	%	Efficiency estimate at full load
Factor_Z	0.5		Loss allocation factor
PRIMARY CONTROLLER			
Device	LYT6079C		Device Code
Vdrain_Breakdown	750	V	Device Breakdown Voltage
Ilimit_Mode	Increased		Device current limit mode
Ilimit_min	3.23	A	Minimum current limit of primary switch
Ilimit_typ	3.47	A	Typical current limit of primary switch
Ilimit_max	3.72	A	Maximum current limit of primary switch
Ratio	0.75		Boost Inductance and Flyback Primary Inductance Ratio
VOR	120	V	Secondary Voltage reflected in the Primary Winding
VDS Max	386.68	V	Peak Drain to Source Voltage during FET turn off
BOOST CONVERTER			
Iboost_rms	622.91	mA	Boost RMS current
Iboost_max	1685.55	mA	Boost maximum current
PF_estimate	0.73		Estimated Power Factor
FLYBACK CONVERTER			
Fsw_min	45	kHz	Minimum Switching frequency in a Line period
Fsw_max	91.94	kHz	Maximum Switching frequency in a Line period
Ipri_rms	725.1	mA	Primary Winding RMS current
Ifet_rms	987.22	mA	FET RMS current
Ipk_max	2656.52	mA	Primary Winding peak current
Idrain_max	2975.83	mA	FET maximum current
Isec_rms	4766.62	mA	Secondary Winding RMS current
Iout_calculated	2698.93	mA	Calculated Output current
SPIV_max	61.34	V	Secondary Rectifier Inverse voltage
PIV_pbias	35.33	V	Primary Bias Rectifier Inverse voltage
PIV_aux	35.33	V	Auxiliary Winding Rectifier Inverse voltage
BOOST INDUCTOR DESIGN			
Lboost	328.5	uH	Boost Inductor inductance value
Core	EE19		Boost Core
N_boost	73	turns	Boost inductor number of turns
Layer_boost	5	layers	Boost inductor layer of windings
#filar_boost	1	filar	Number of filar of winding
AWG_boost	24	AWG	Boost inductor wire used
CMA_boost	649		Boost inductor wire CMA
FLYBACK TRANSFORMER DESIGN			
Lp	438	uH	Flyback Transformer inductance value
Core	RM10		Flyback Core
Np	40	turns	Primary winding number of turns
Layer_pri	2	layers	Primary winding number of layers
#filar_pri	2	filar	Primary winding number of filars used
AWG_pri	32	AWG	Primary winding wire used
CMA_pri	350		Primary winding wire CMA
Ns	8	turns	Secondary winding number of turns
Layer_sec	2	layers	Secondary winding number of layers
#filar_sec	3	filar	Secondary winding number of filars used
AWG_sec	24	TIW	Secondary winding wire used
CMA_sec	1363		Secondary winding wire CMA

V_bias	12	V	Bias winding voltage
N_bias	5	turns	Bias winding number of turns
Layer_bias	1	layers	Bias winding number of layers
#filar_bias	1	filar	Bias winding number of filars used
AWG_bias	32	AWG	Bias winding wire used
COMPONENT SELECTION			
CBULK	100	uF	Bulk capacitor
CBIAS	22	uF	Bias winding capacitor
CBPP	4.7	uF	BPP pin capacitor
RFWD	47	Ohms	FWD pin resistor
CBPS	2.2	uF	BPS pin capacitor
RUPPER	100	kOhms	Upper feedback resistor
RLOWER	5.56	kOhms	Lower feedback resistor
CLOWER	330	pF	Lower feedback decoupling capacitor
RSENSE	0.013	Ohms	Output Sense resistor

This design spreadsheet is derived from MathCAD calculation since the part used (LYT6079C) is not available in PI Expert Suite.



10 Performance Data

All measurements were performed at room temperature.

10.1 *Output Voltage Regulation*

Set-up:	Open frame unit.
Load:	24 V 2.7 A E-Load CC load.
Ambient Temperature:	25 °C.
Soak Time:	60 seconds.

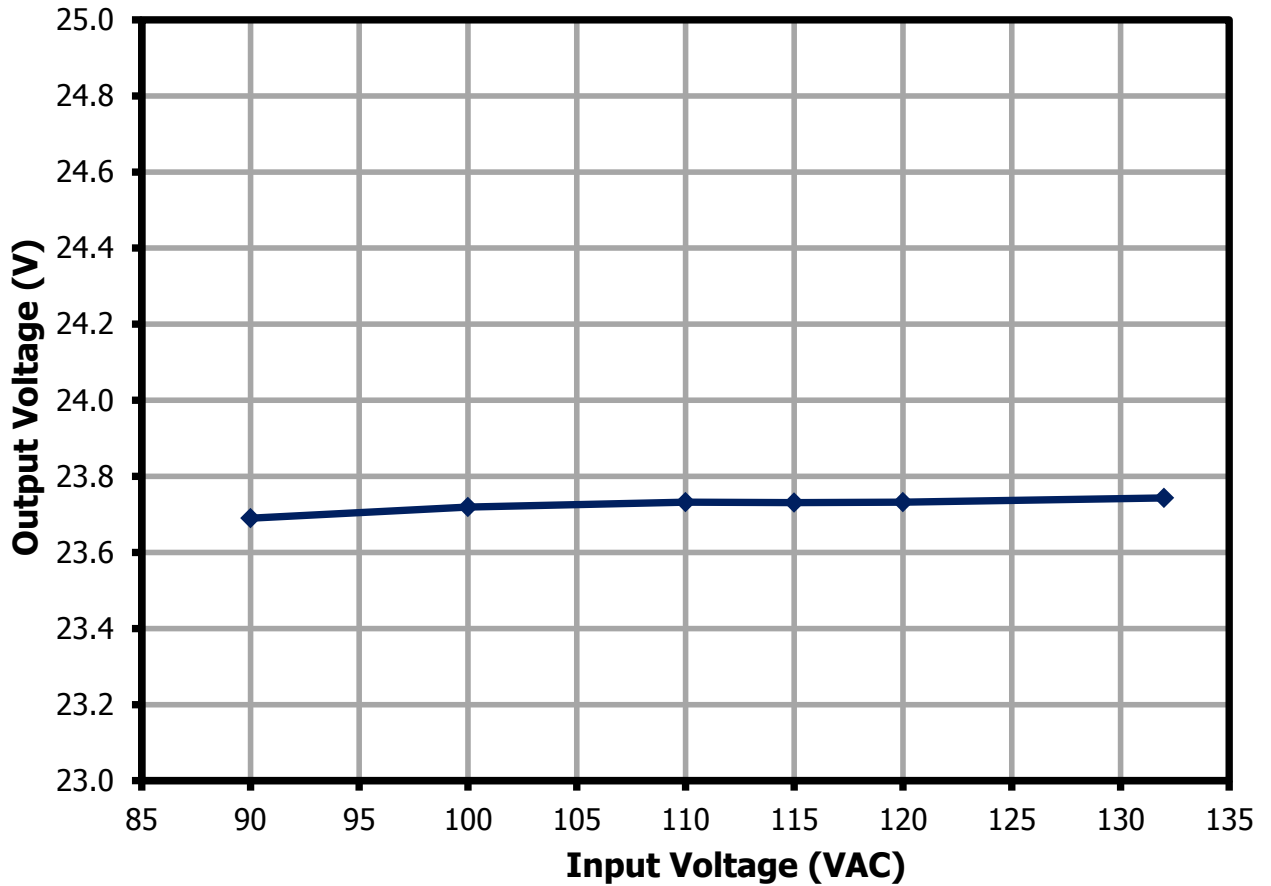

Figure 11 – Output Voltage Regulation vs. Input Line Voltage.

10.2 **System Efficiency**

Set-up: Open frame unit.
Load: 24 V 2.7 A E-Load CC load.
Ambient Temperature: 25 °C.
Soak Time: 60 seconds.

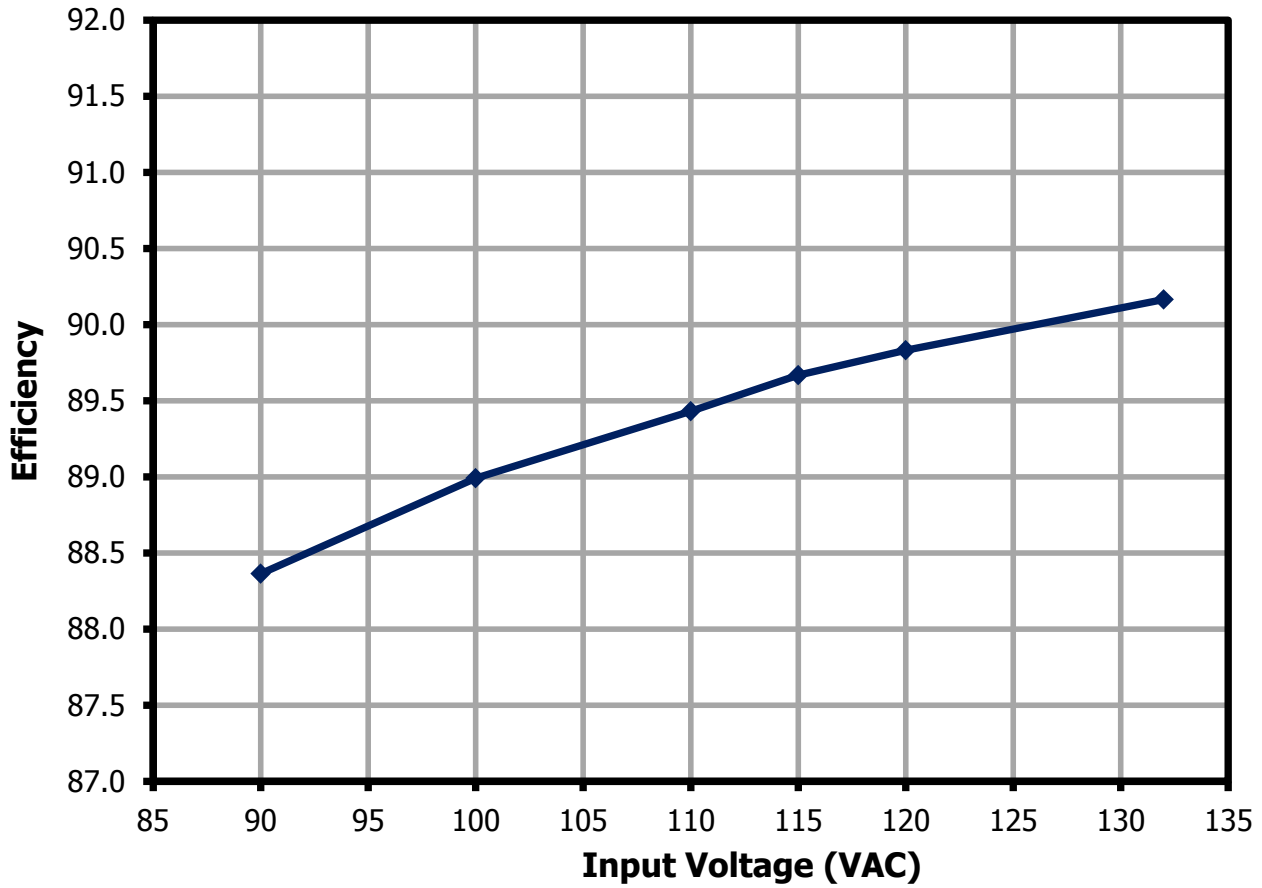

Figure 12 – Efficiency vs. Input Line Voltage.

10.3 Power Factor

Set-up: Open frame unit.
Load: 24 V 2.7 A E-Load CC load.
Ambient Temperature: 25 °C.
Soak Time: 60 seconds.

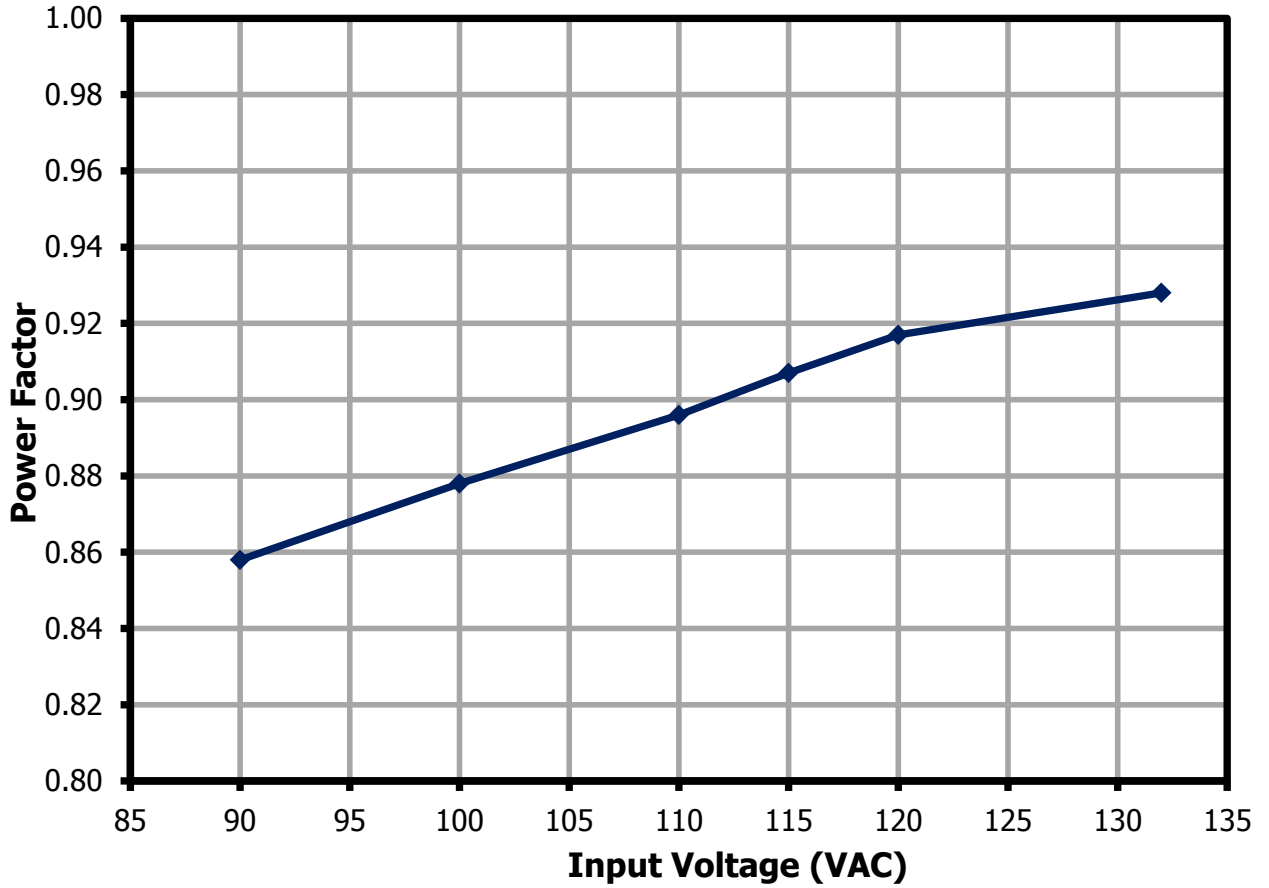

Figure 13 – Power Factor vs. Input Line Voltage.



10.4 %ATHD

Set-up: Open frame unit.
Load: 24 V 2.7 A E-Load CC load.
Ambient Temperature: 25 °C.
Soak Time: 60 seconds.

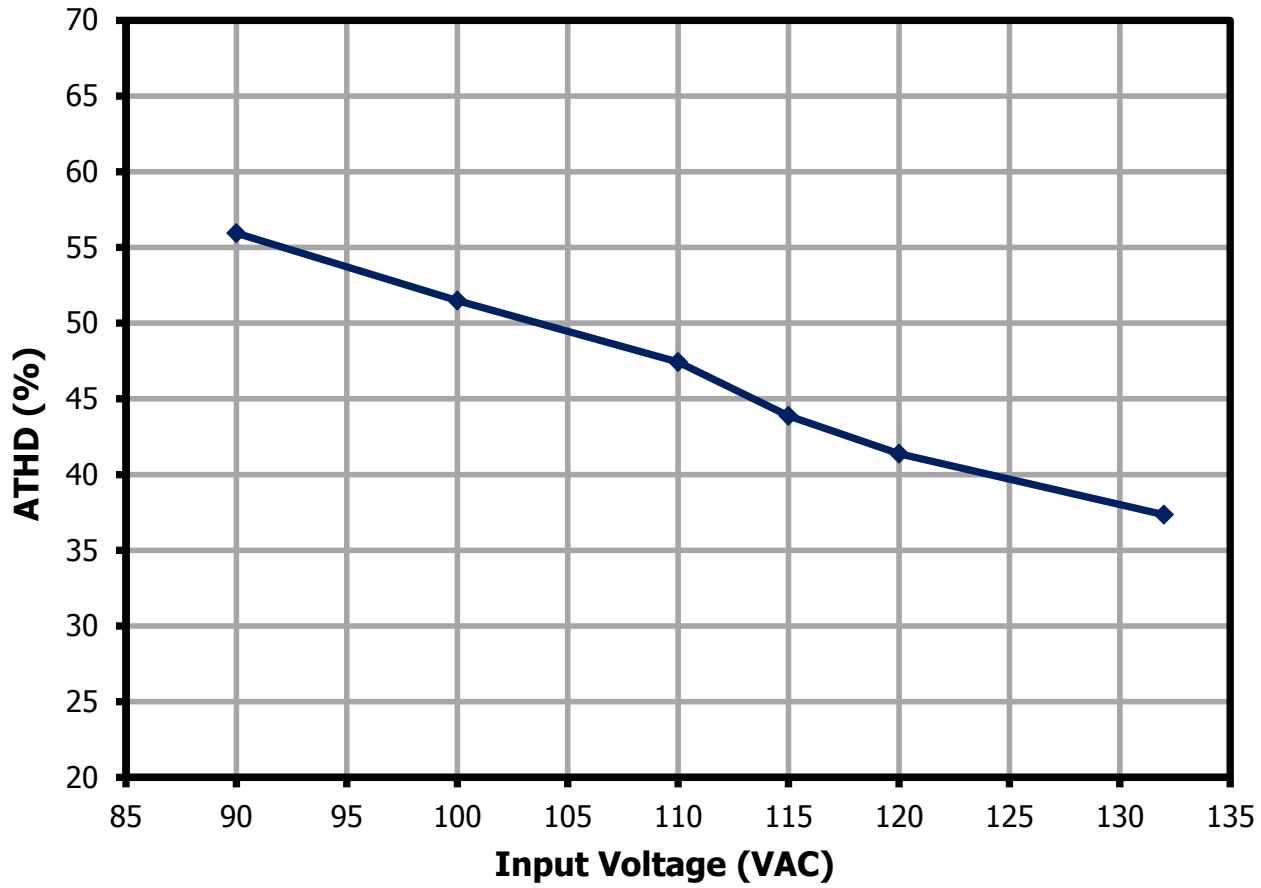

Figure 14 – %ATHD vs. Input Line Voltage.

10.5 *No-Load Input Power*

Set-up: Open frame unit.
Load: Open load.
Ambient Temperature: 25 °C.
Soak Time: 60 seconds.
Integration Time: 300 seconds per line.

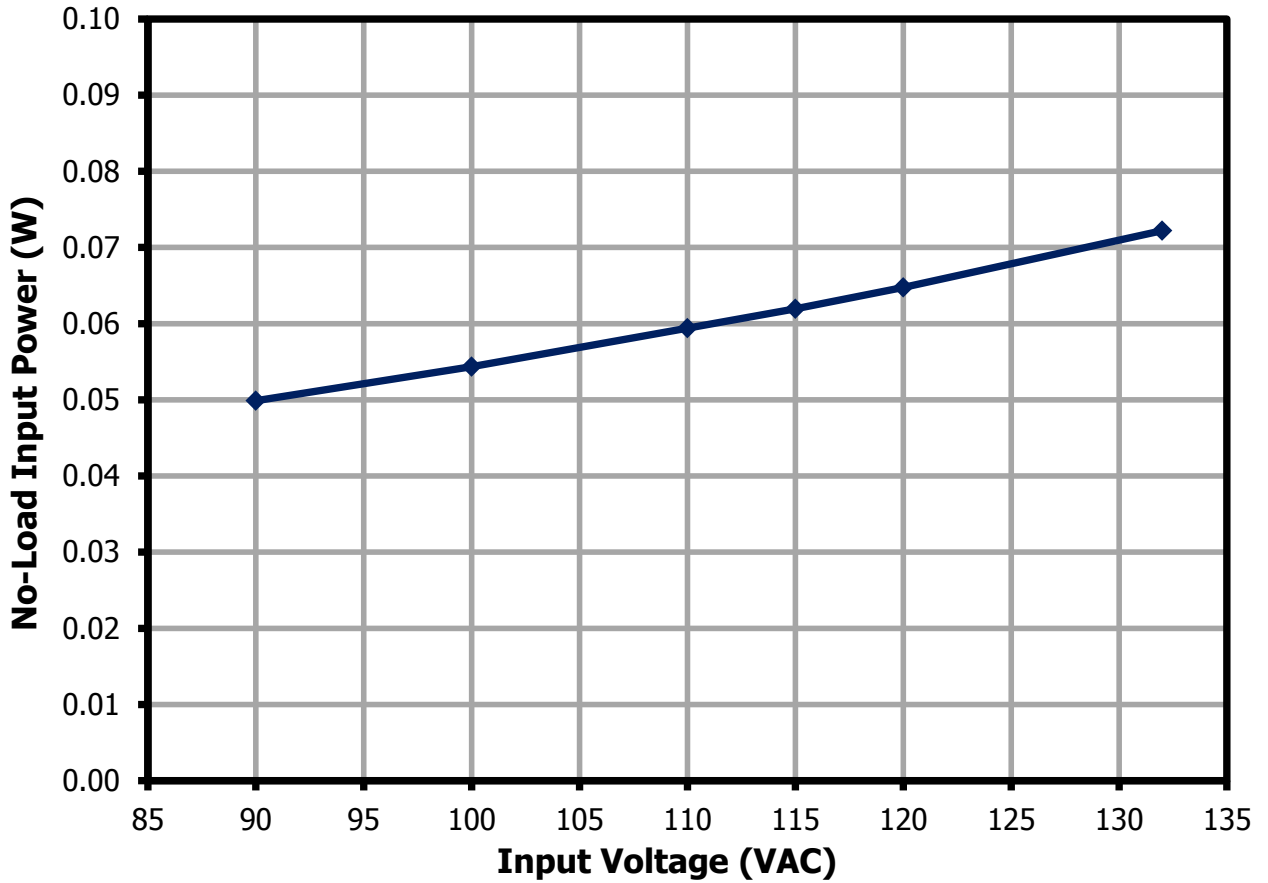

Figure 15 – No-Load Input Power vs. Input Line Voltage.



10.6 **Output Voltage Regulation vs. Load**

Set-up: Open frame unit.
Load: E-Load in CC mode.
Ambient Temperature: 25 °C.

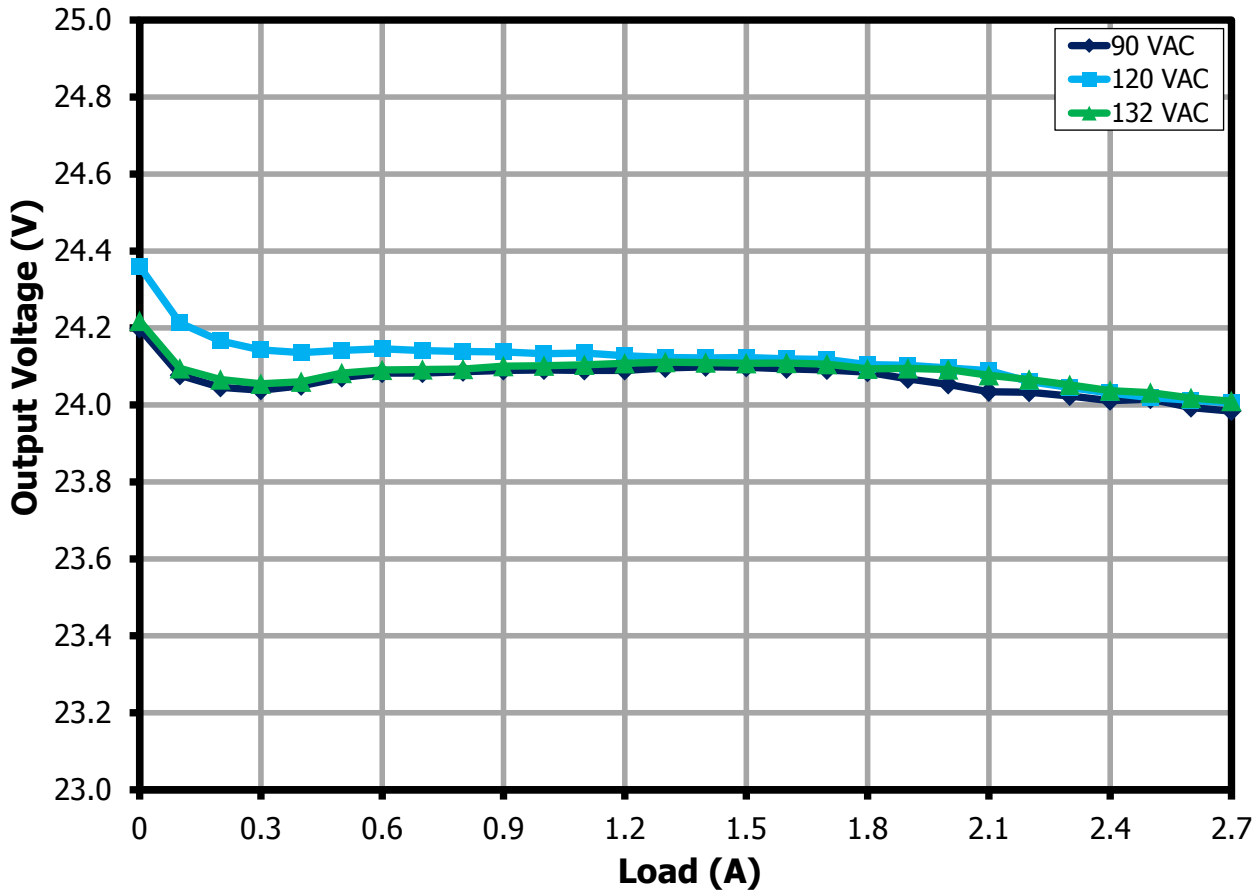

Figure 16 – Output Voltage Regulation vs. Load.

10.7 Efficiency vs. Load

Set-up: Open frame unit.
Load: E-Load in CC mode.
Ambient Temperature: 25 °C.

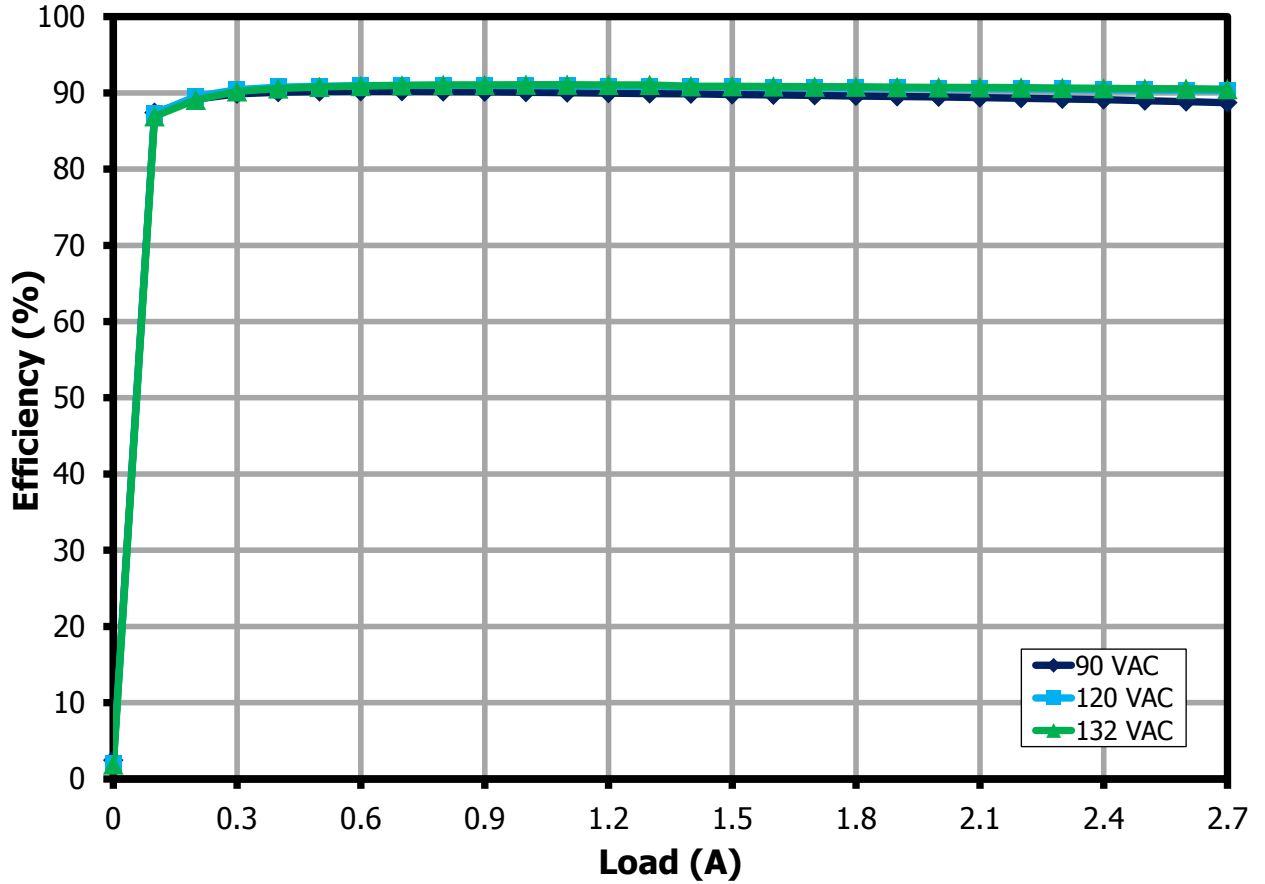

Figure 17 – Efficiency vs. Load.



11 Test Data

11.1 Test Data at Full Load

Input		Input Measurement					LED Load Measurement			Efficiency (%)
VAC (V _{RMS})	Freq (Hz)	V _{IN} (V _{RMS})	I _{IN} (mA _{RMS})	P _{IN} (W)	PF	%ATHD	V _{OUT} (V _{DC})	I _{OUT} (mA _{DC})	P _{OUT} (W)	
90	60	89.85	938.2	72.36	0.86	55.94	23.69	2698.9	63.94	88.36
100	60	99.9	820.1	71.94	0.88	51.49	23.72	2698.9	64.02	88.99
110	60	109.86	728	71.62	0.90	47.43	23.73	2698.9	64.05	89.43
115	60	114.93	685.5	71.43	0.91	43.87	23.73	2698.9	64.05	89.67
120	60	119.91	648.4	71.3	0.92	41.38	23.73	2698.9	64.05	89.83
132	60	131.93	580.8	71.07	0.93	37.34	23.74	2698.8	64.08	90.16

11.2 Test Data at No-Load

Input				
VAC (V _{RMS})	Freq (Hz)	V _{IN} (V _{RMS})	I _{IN} (mA _{RMS})	P _{IN} (W)
90	60	89.95	53.17	0.050
100	60	99.99	53.01	0.054
110	60	109.94	52.82	0.059
115	60	115.01	52.87	0.062
120	60	119.99	52.85	0.065
132	60	132	52.73	0.072

11.3 Test Data at different Loads

11.3.1 90 VAC Input

Load (A)	Input Measurement					LED Load Measurement			Efficiency (%)
	V _{IN} (V _{RMS})	I _{IN} (mA _{RMS})	P _{IN} (W)	PF	%ATHD	V _{OUT} (V _{DC})	I _{OUT} (mA _{DC})	P _{OUT} (W)	
0	89.96	53.88	0.04	0.01	26.18	24.20	0.02	0.00	2.44
0.1	89.94	74.05	2.75	0.41	61.59	24.08	99.82	2.40	87.38
0.2	89.92	93.68	5.39	0.64	70.76	24.05	199.82	4.81	89.18
0.3	89.90	124.21	8.02	0.72	67.87	24.04	299.79	7.21	89.86
0.4	89.88	156.58	10.68	0.76	67.45	24.05	399.84	9.62	90.08
0.5	89.94	192.11	13.34	0.77	66.98	24.07	499.81	12.03	90.17
0.6	89.93	225.02	16.01	0.79	64.45	24.08	599.77	14.45	90.21
0.7	89.93	259.69	18.68	0.80	63.47	24.08	699.70	16.85	90.19
0.8	89.92	295.42	21.36	0.80	63.42	24.09	799.70	19.26	90.17
0.9	89.91	330.06	24.05	0.81	62.64	24.09	899.70	21.68	90.13
1	89.91	364.62	26.73	0.82	61.66	24.09	999.30	24.08	90.08
1.1	89.91	398.35	29.42	0.82	60.77	24.09	1099.30	26.48	90.02
1.2	89.91	430.74	32.12	0.83	60.26	24.09	1199.30	28.89	89.96
1.3	89.90	463.71	34.82	0.84	60.81	24.10	1299.30	31.31	89.92
1.4	89.90	497.40	37.52	0.84	59.90	24.10	1399.20	33.72	89.87
1.5	89.89	532.30	40.23	0.84	61.30	24.10	1499.10	36.13	89.80
1.6	89.89	568.50	42.94	0.84	60.37	24.09	1599.10	38.53	89.73
1.7	89.88	605.10	45.65	0.84	61.89	24.09	1699.10	40.93	89.67
1.8	89.88	641.60	48.37	0.84	61.26	24.09	1799.10	43.33	89.59
1.9	89.88	678.00	51.06	0.84	61.31	24.07	1899.10	45.71	89.52
2	89.87	714.70	53.75	0.84	61.76	24.05	1999.10	48.09	89.46
2.1	89.87	747.80	56.44	0.84	61.27	24.03	2099.10	50.45	89.39
2.2	89.86	784.00	59.19	0.84	61.38	24.03	2199.10	52.85	89.29
2.3	89.86	816.00	61.91	0.84	60.26	24.02	2299.00	55.23	89.21
2.4	89.86	850.00	64.64	0.85	58.99	24.01	2399.00	57.60	89.11
2.5	89.85	887.10	67.45	0.85	59.41	24.02	2499.00	60.02	88.98
2.6	89.84	928.50	70.19	0.84	60.73	23.99	2599.00	62.36	88.84
2.7	89.83	970.30	72.97	0.84	60.97	23.98	2698.90	64.73	88.71

11.3.2 120 VAC Input

Load (A)	Input Measurement					LED Load Measurement			Efficiency (%)
	V _{IN} (V _{RMS})	I _{IN} (mA _{RMS})	P _{IN} (W)	PF	%ATHD	V _{OUT} (V _{DC})	I _{OUT} (mA _{DC})	P _{OUT} (W)	
0	119.99	53.06	0.05	0.01	19.54	24.36	0.02	0.00	1.96
0.1	119.98	65.81	2.77	0.35	43.58	24.21	99.92	2.42	87.30
0.2	119.96	78.79	5.40	0.57	55.20	24.17	199.88	4.83	89.51
0.3	119.95	99.11	8.00	0.67	60.40	24.14	299.75	7.24	90.42
0.4	119.93	121.39	10.64	0.73	58.14	24.14	399.81	9.65	90.74
0.5	119.92	145.40	13.28	0.76	59.10	24.14	499.81	12.07	90.87
0.6	119.97	171.40	15.92	0.77	58.61	24.15	599.79	14.48	90.96
0.7	119.97	195.82	18.56	0.79	59.14	24.14	699.70	16.89	91.00
0.8	119.97	221.54	21.22	0.80	58.61	24.14	799.70	19.30	90.99
0.9	119.96	247.43	23.87	0.80	58.80	24.14	899.70	21.72	90.98
1	119.96	272.87	26.52	0.81	59.45	24.13	999.30	24.12	90.94
1.1	119.95	296.98	29.18	0.82	57.56	24.14	1099.30	26.53	90.92
1.2	119.95	319.43	31.84	0.83	57.80	24.13	1199.30	28.94	90.88
1.3	119.95	340.98	34.50	0.84	55.31	24.12	1299.30	31.34	90.86
1.4	119.94	363.94	37.17	0.85	56.32	24.12	1399.20	33.75	90.82
1.5	119.94	387.76	39.84	0.86	55.71	24.12	1499.10	36.16	90.77
1.6	119.94	412.16	42.51	0.86	55.13	24.12	1599.10	38.57	90.74
1.7	119.94	436.69	45.18	0.86	55.23	24.12	1699.10	40.98	90.70
1.8	119.93	461.47	47.83	0.86	54.41	24.11	1799.20	43.37	90.67
1.9	119.93	487.20	50.51	0.87	55.29	24.10	1899.10	45.78	90.63
2	119.92	512.90	53.18	0.87	54.85	24.10	1999.20	48.17	90.58
2.1	119.92	538.20	55.85	0.87	55.50	24.09	2099.10	50.57	90.54
2.2	119.92	563.20	58.46	0.87	55.07	24.06	2199.20	52.92	90.52
2.3	119.91	587.60	61.09	0.87	54.51	24.05	2299.00	55.28	90.49
2.4	119.91	615.10	63.77	0.87	55.62	24.03	2399.00	57.65	90.41
2.5	119.90	638.20	66.42	0.87	54.55	24.02	2499.00	60.03	90.37
2.6	119.91	663.10	69.08	0.87	55.04	24.01	2599.00	62.41	90.34
2.7	119.91	688.10	71.77	0.87	54.11	24.01	2698.90	64.79	90.27

11.3.3 132 VAC Input

Load (A)	Input Measurement					LED Load Measurement			Efficiency (%)
	V _{IN} (V _{RMS})	I _{IN} (mA _{RMS})	P _{IN} (W)	PF	%ATHD	V _{OUT} (V _{DC})	I _{OUT} (mA _{DC})	P _{OUT} (W)	
0	131.96	53.20	0.05	0.01	9.19	24.22	0.03	0.00	1.89
0.1	131.95	66.72	2.77	0.32	41.24	24.10	99.91	2.41	86.93
0.2	131.94	75.92	5.40	0.54	50.25	24.07	199.90	4.81	89.09
0.3	131.93	93.23	8.00	0.65	53.63	24.06	300.12	7.22	90.19
0.4	131.92	113.02	10.63	0.71	56.57	24.06	400.13	9.63	90.58
0.5	131.91	134.34	13.27	0.75	56.12	24.08	500.12	12.04	90.78
0.6	131.90	155.25	15.90	0.78	56.56	24.09	600.07	14.46	90.91
0.7	131.96	178.76	18.53	0.79	56.82	24.09	699.90	16.86	91.00
0.8	131.96	201.55	21.17	0.80	55.56	24.09	799.90	19.27	91.05
0.9	131.96	224.27	23.82	0.81	55.60	24.10	899.90	21.69	91.06
1	131.95	247.19	26.46	0.81	55.68	24.10	999.50	24.09	91.06
1.1	131.95	269.90	29.10	0.82	56.42	24.10	1099.40	26.50	91.07
1.2	131.95	290.13	31.76	0.83	54.31	24.11	1199.50	28.92	91.05
1.3	131.95	309.19	34.42	0.84	54.36	24.11	1299.50	31.33	91.04
1.4	131.94	328.91	37.13	0.86	52.63	24.11	1399.40	33.74	90.87
1.5	131.94	349.46	39.78	0.86	53.10	24.11	1499.30	36.15	90.87
1.6	131.94	371.28	42.45	0.87	53.57	24.11	1599.20	38.56	90.83
1.7	131.94	392.71	45.10	0.87	51.39	24.11	1699.30	40.96	90.82
1.8	131.93	413.89	47.74	0.87	51.26	24.09	1799.30	43.35	90.80
1.9	131.93	437.37	50.43	0.87	51.82	24.10	1899.20	45.76	90.75
2	131.93	459.90	53.10	0.88	51.38	24.09	1999.30	48.17	90.72
2.1	131.93	480.52	55.72	0.88	51.05	24.08	2099.30	50.54	90.71
2.2	131.92	502.60	58.36	0.88	50.26	24.07	2199.30	52.93	90.69
2.3	131.93	526.00	61.01	0.88	51.48	24.05	2299.10	55.30	90.64
2.4	131.92	547.40	63.64	0.88	50.88	24.04	2399.10	57.67	90.61
2.5	131.92	572.20	66.32	0.88	51.66	24.03	2499.10	60.06	90.56
2.6	131.92	591.80	68.94	0.88	50.58	24.02	2599.10	62.43	90.55
2.7	131.91	613.40	71.61	0.89	49.98	24.01	2698.90	64.80	90.49

12 Thermal Performance

12.1 *Thermal Measurements at Ambient Room Temperature*

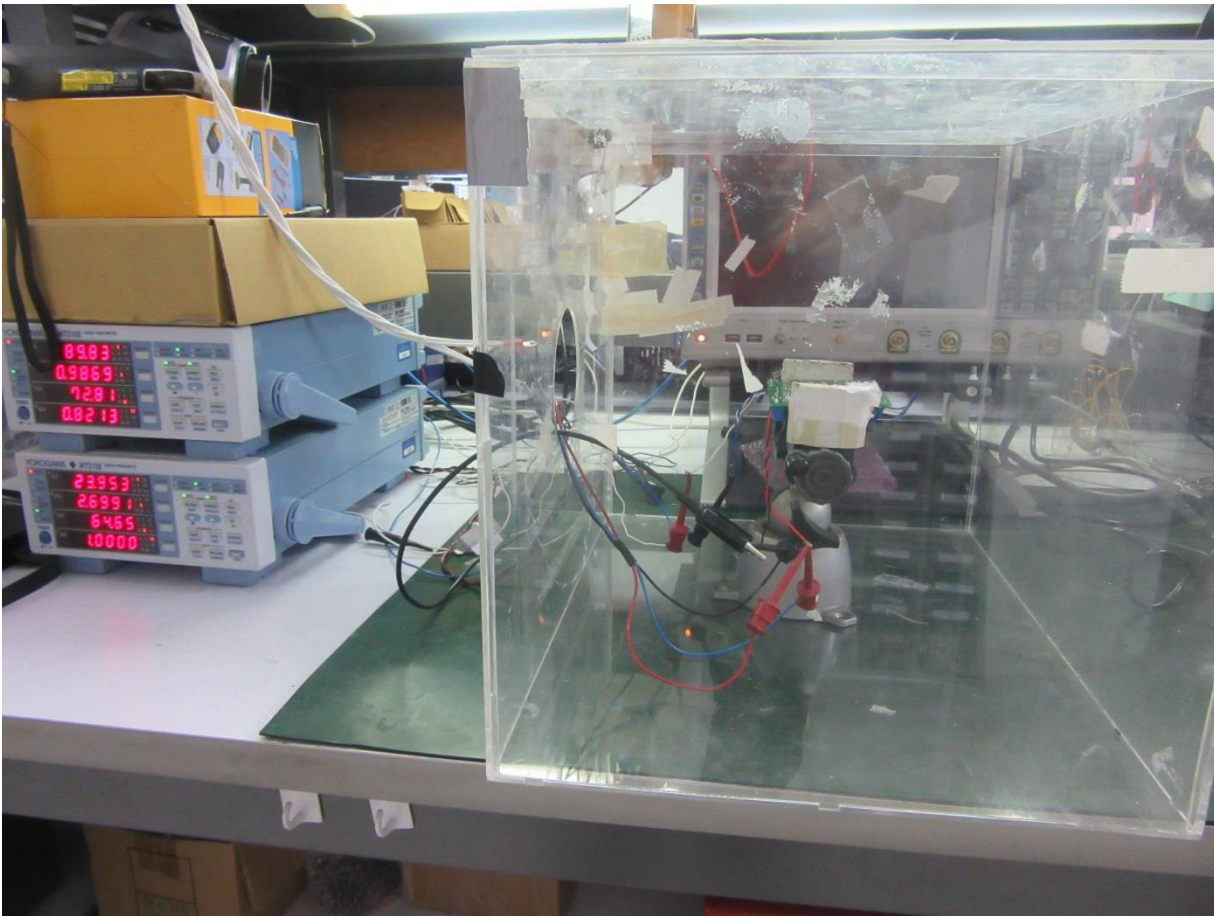

Figure 18 – Test Set-up Picture - Open Frame.

Unit in open frame was placed inside the acrylic enclosure to prevent airflow that might affect the thermal measurements. Temperature was measured at 90 VAC using the FLIR E60 Thermal Camera.

Equipment used:

1. KEYSIGHT 6812B AC Power Source/Analyzer
2. Chroma 63110A DC Electronic Load Mainframe
3. FLIR E60 Thermal Camera
4. Yokogawa WT310E Digital Power Meter

Ref Des	Description	Temperature Reading (°C)
U4	LYTSwitch-6 IC	113
Q1	SR-FET	94.1
T1	PFC Inductor	80.6
T2	DCDC Transformer Primary	96.5
D1	PFC Diode	103
BR1	Bridge Diode	92.6
AMBIENT		28.5

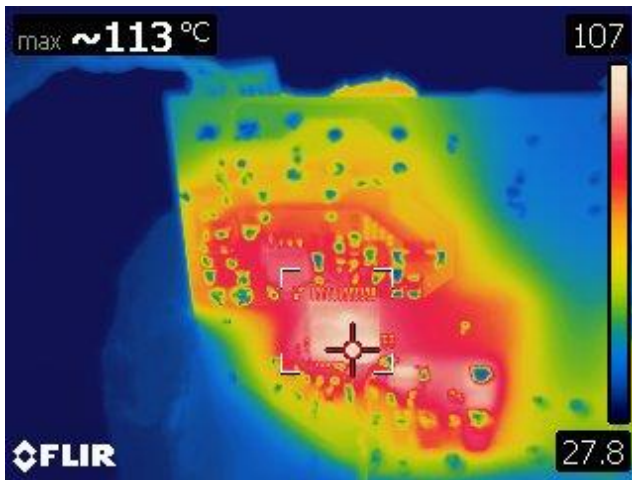

Figure 19 – LYTSwitch-6 (U4).

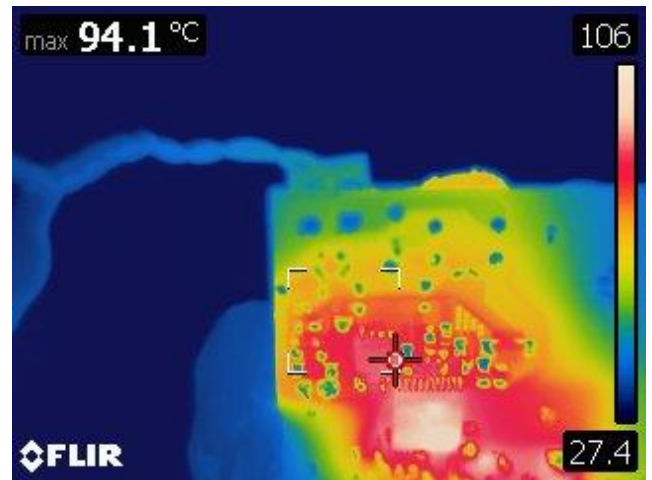

Figure 20 – SR-FET (Q1).

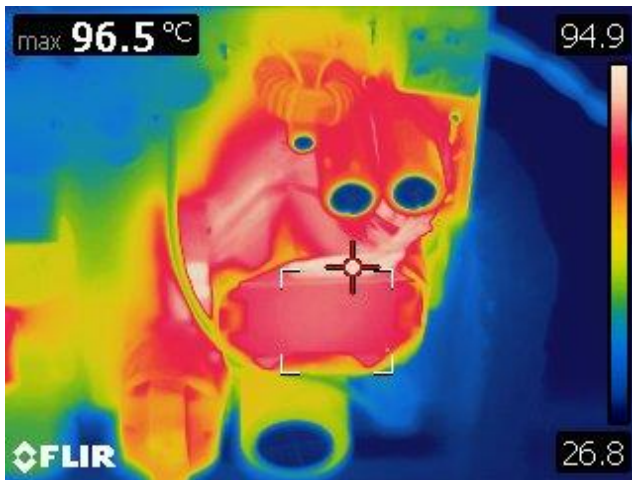

Figure 21 – Flyback Transformer (T2).

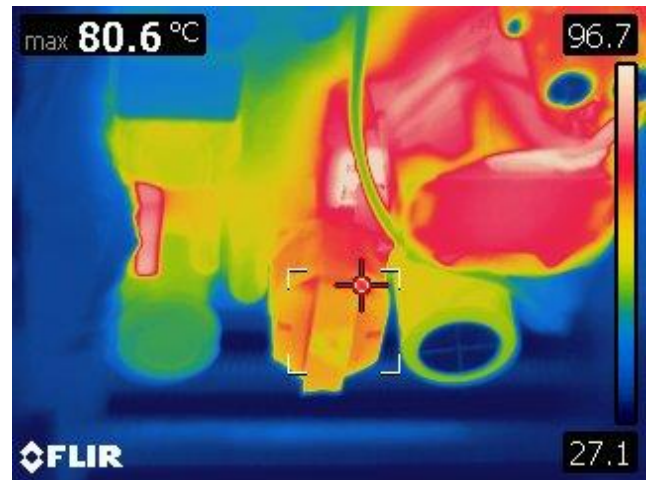

Figure 22 – PFC Inductor (T1).

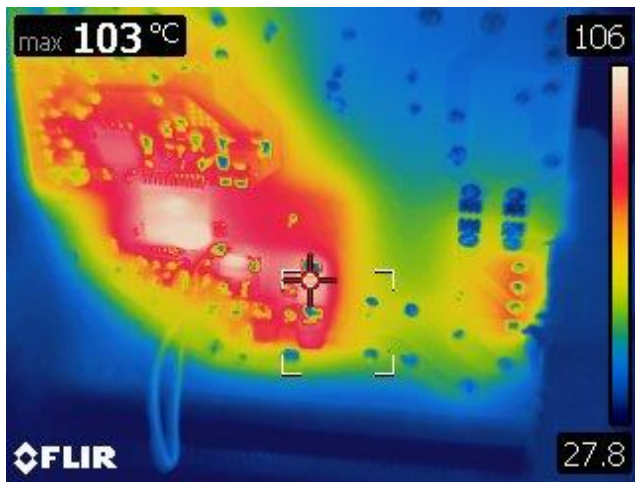

Figure 23 – PFC Diode (D1).

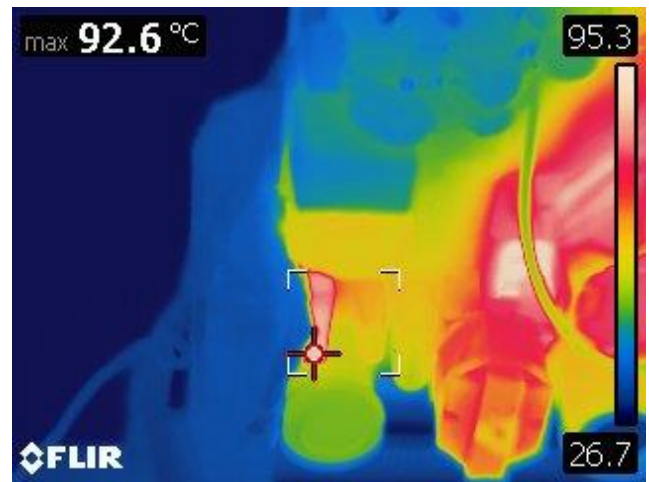

Figure 24 – Bridge Diode (BR1).

12.2 *Thermal Performance at High Ambient Temperature*

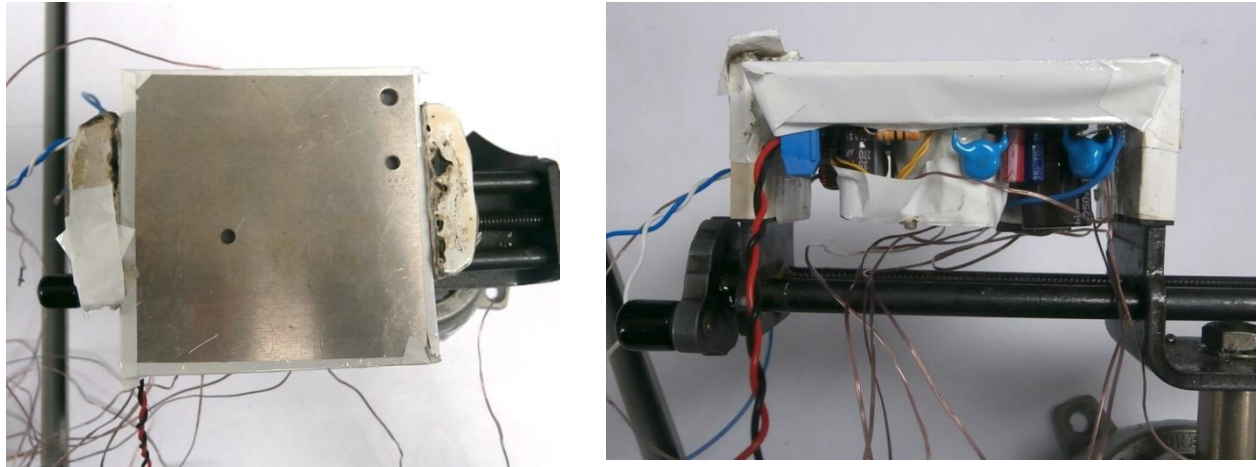

Figure 25 – Test Set-up Picture – Placement of Metal Heat Sink and Thermal Padding.



Figure 26 – Test Set-up Picture – Unit in Enclosure Placed Inside Thermal Chamber.

Unit in open frame with 4.5 mm thick thermal padding and 3 mm thick metal heat sink placed on bottom/solder side was positioned inside an enclosure to prevent airflow that might affect the thermal measurements. The enclosure is placed inside the thermal chamber. Ambient temperature inside the enclosure is 50 °C. Temperature was measured using type T thermocouple. Soak time at full load is more than 2 hours.

Equipment used:

1. KEYSIGHT 6812B AC Power Source/Analyzer
2. Chroma 6314A DC Electronic Load Mainframe and Chroma 63110A DC Electronic Load
3. Yokogawa Data Logger
4. Yokogawa WT310E Digital Power Meter
5. SPX Tenney TUJR Thermal Chamber

Ref Des	Description	Temperature Reading (°C)
U4	LYTSwitch-6 Primary/FET	104.1
U4	LYTSwitch-6 Secondary	103.6
Q1	SR FET	91.8
T1	PFC Inductor	81
T2	DCDC Transformer	93.4
BR1	Bridge Diode	86
D1	PFC Diode	80.1
D17	PFC Diode	90.7
D18	Output Diode	77.5
AMBIENT		50.8

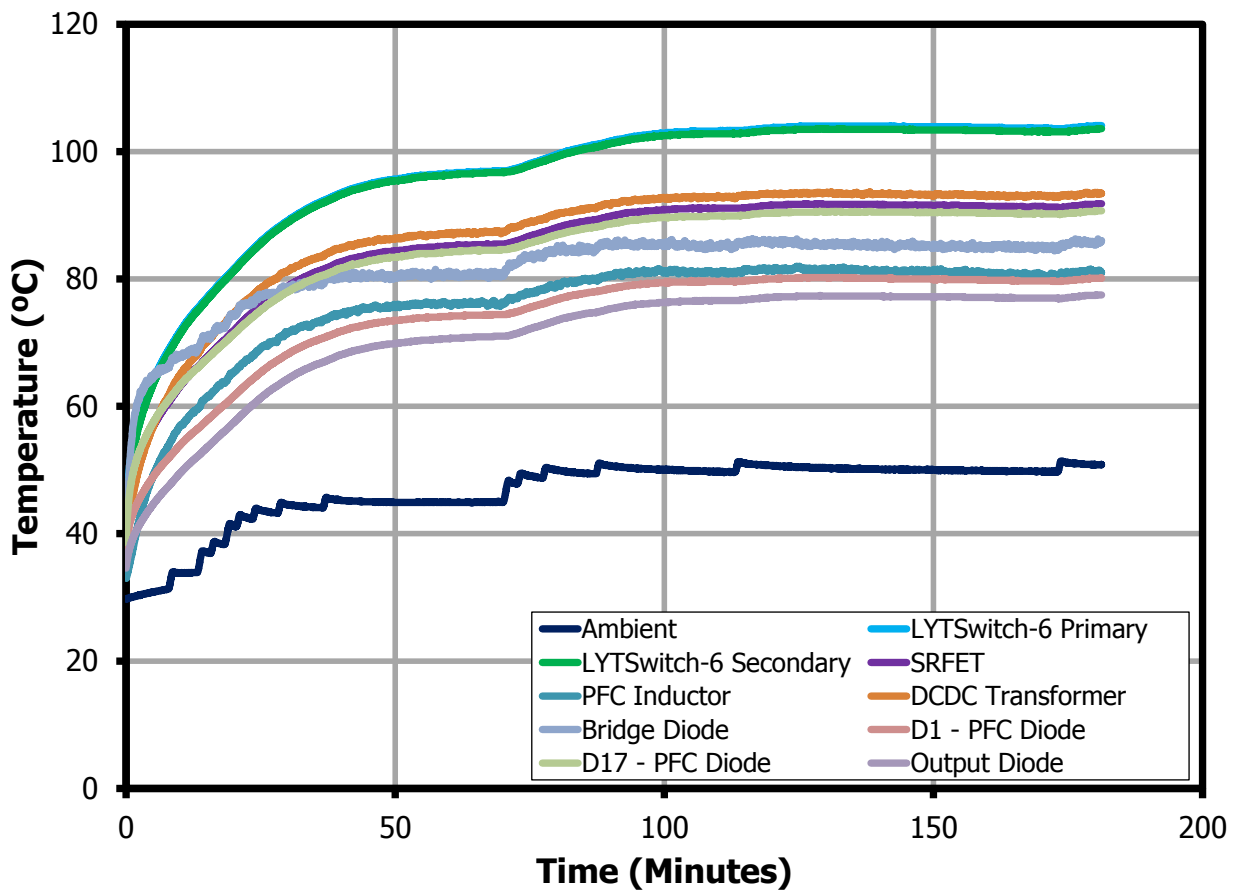

Figure 27 – Thermal Scan at 90 VAC – 50 °C Ambient Temperature.

13 Waveforms

Waveforms were taken at room temperature (25 °C).

13.1 *Input Voltage and Input Current at Full Load*

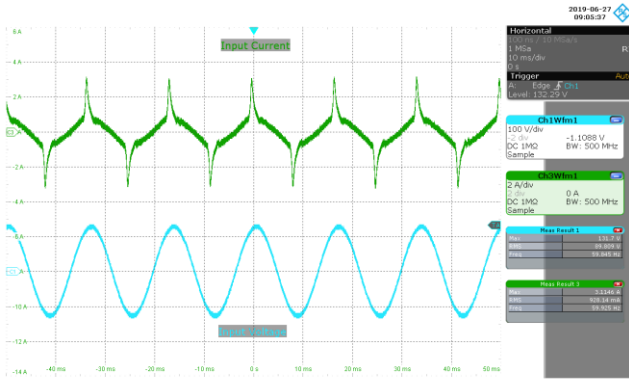

Figure 28 – 90 VAC 60 Hz, Full Load.
Upper: I_{IN} , 2 A / div
Lower: V_{IN} , 100 V / div, 10 ms / div.

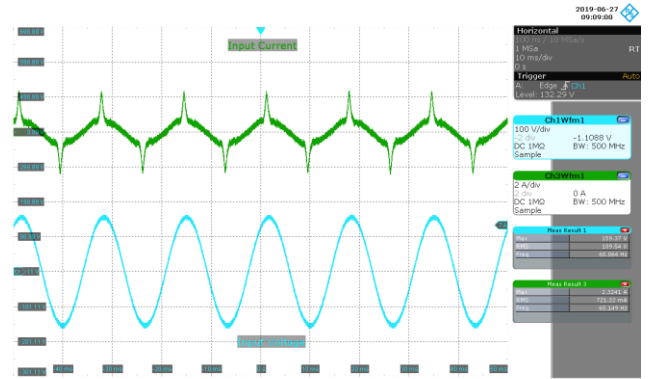

Figure 29 – 110 VAC 60 Hz, Full Load.
Upper: I_{IN} , 2 A / div.
Lower: V_{IN} , 100 V / div., 10 ms / div.

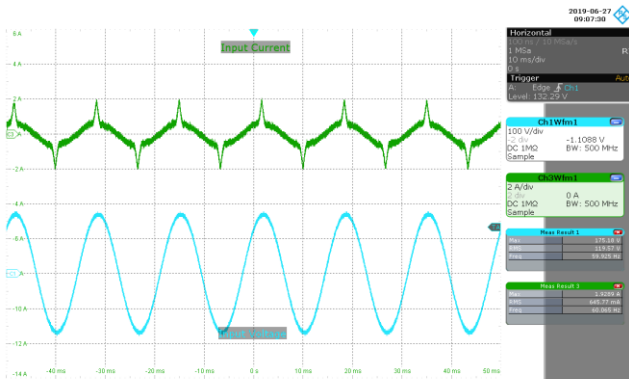

Figure 30 – 120 VAC 60 Hz, Full Load.
Upper: I_{IN} , 2 A / div.
Lower: V_{IN} , 100 V / div., 10 ms / div.

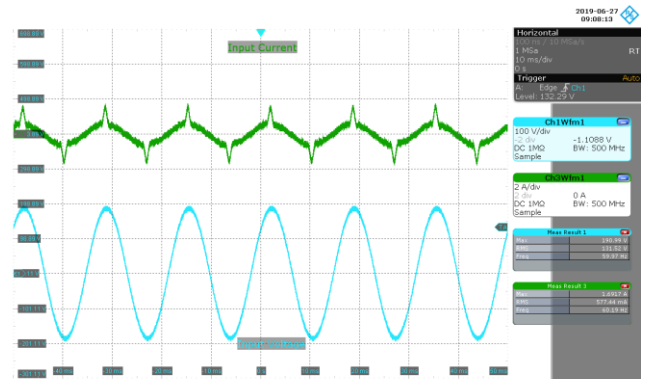

Figure 31 – 132 VAC 60 Hz, Full Load.
Upper: I_{IN} , 2 A / div.
Lower: V_{IN} , 100 V / div., 10 ms / div.

13.2 **Start-up Profile at Full Load**

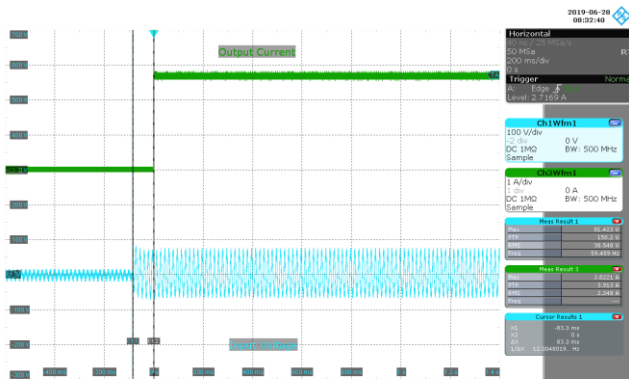

Figure 32 – 90 VAC 60 Hz, Full Load Start-up.
 Upper: I_{OUT} , 1 A / div.
 Lower: V_{IN} , 100 V / div., 200 ms / div.
 Turn On Time: 83.3 ms.

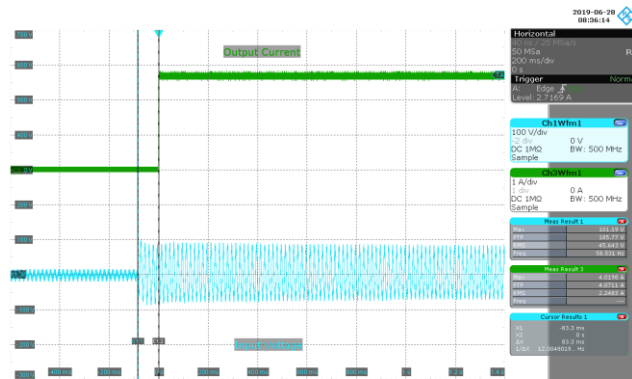

Figure 33 – 110 VAC 60 Hz, Full Load Start-up.
 Upper: I_{OUT} , 1 A / div.
 Lower: V_{IN} , 100 V / div., 200 ms / div.
 Turn On Time: 83.3 ms.

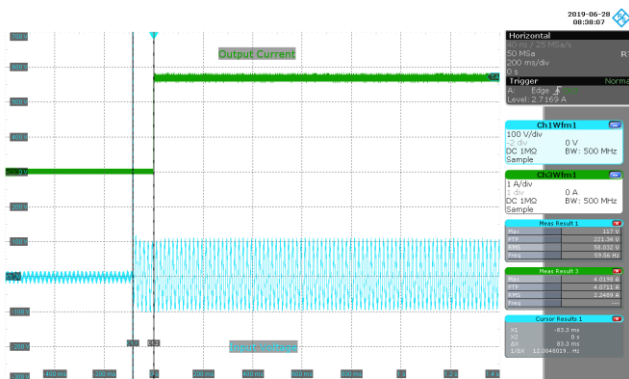

Figure 34 – 120 VAC 60 Hz, Full Load Start-up.
 Upper: I_{OUT} , 1 A / div.
 Lower: V_{IN} , 100 V / div., 200 ms / div.
 Turn On Time: 83.3 ms.

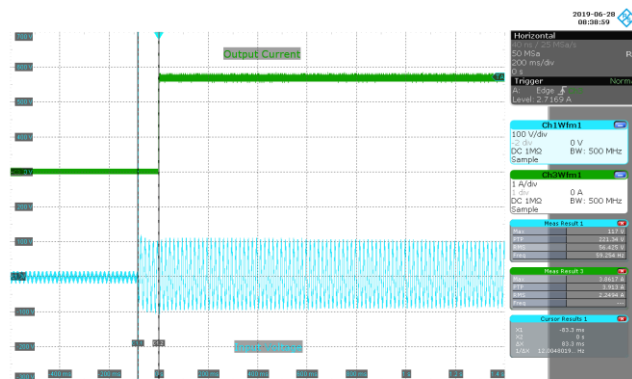

Figure 35 – 132 VAC 60 Hz, Full Load Start-up.
 Upper: I_{OUT} , 1 A / div.
 Lower: V_{IN} , 100 V / div., 200 ms / div.
 Turn On Time: 83.3 ms.

13.3 Turn-Off Profile at Full Load

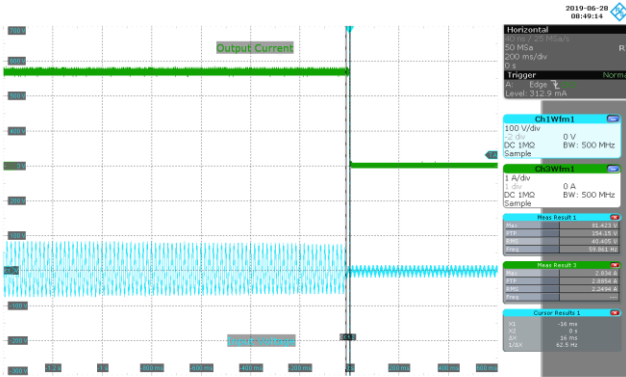

Figure 36 – 90 VAC 60 Hz, Full Load, Output Fall.
Upper: I_{OUT} , 1 A / div.
Lower: V_{IN} , 100 V / div., 200 ms / div.
Turn Off Time: 16 ms.

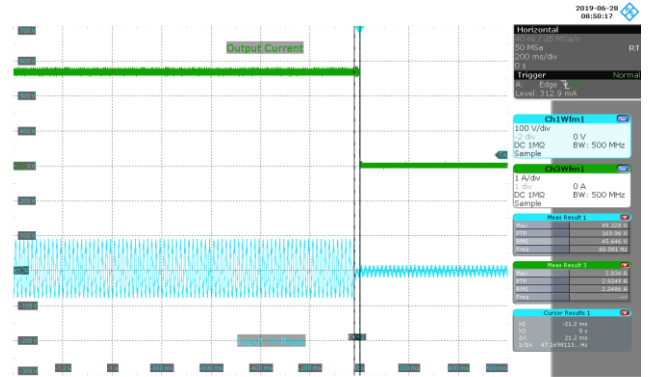

Figure 37 – 110 VAC 60 Hz, Full Load, Output Fall.
Upper: I_{OUT} , 1 A / Div
Lower: V_{IN} , 100 V / div., 200 ms / div.
Turn Off Time: 21.2 ms.

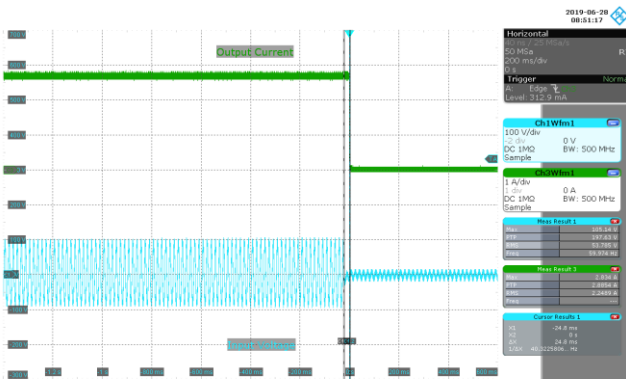

Figure 38 – 120 VAC 60 Hz, Full Load, Output Fall.
Upper: I_{OUT} , 1 A / div.
Lower: V_{IN} , 100 V / div., 200 ms / div.
Turn Off Time: 24.8 ms.

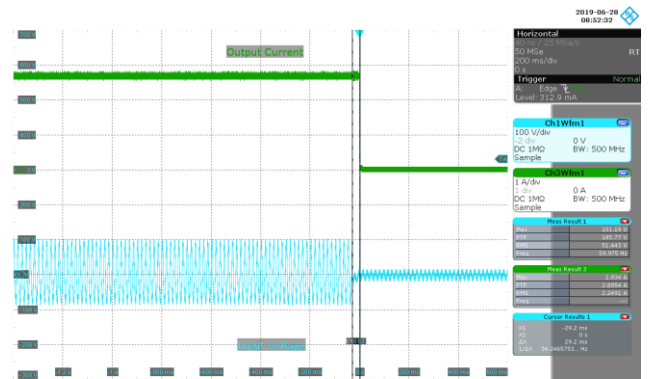

Figure 39 – 132 VAC 60 Hz, Full Load, Output Fall.
Upper: I_{OUT} , 1 A / div.
Lower: V_{IN} , 100 V / div., 200 ms / div.
Turn Off Time: 29.2 ms.



13.4 LYTSwitch-6 Drain Voltage and Current Waveforms at Normal Operation

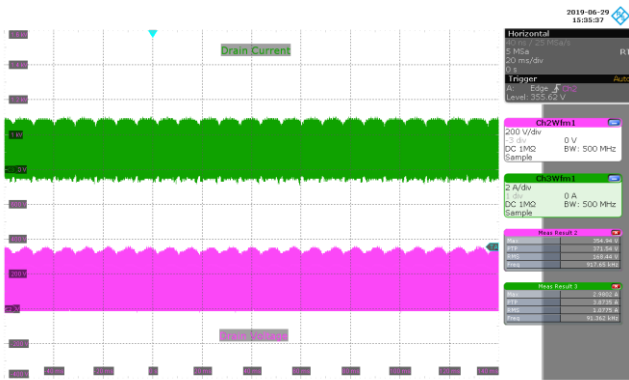

Figure 40 – 90 VAC 60 Hz, Full Load Normal.
 Upper: I_{DRAIN} , 2 A / div.
 Lower: V_{DRAIN} , 200 V / div., 20 ms / div.

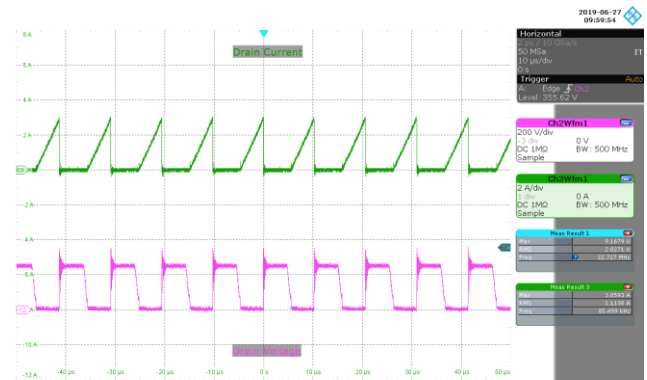

Figure 41 – 90 VAC 60 Hz, Full Load Normal.
 Upper: I_{DRAIN} , 2 A / div.
 Lower: V_{DRAIN} , 200 V / div., 10 μs / div.

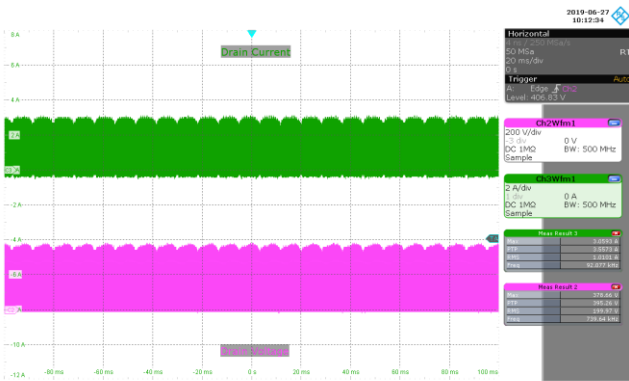

Figure 42 – 110 VAC 60 Hz, Full Load Normal.
 Upper: I_{DRAIN} , 2 A / div.
 Lower: V_{DRAIN} , 200 V / div., 20 ms / div.

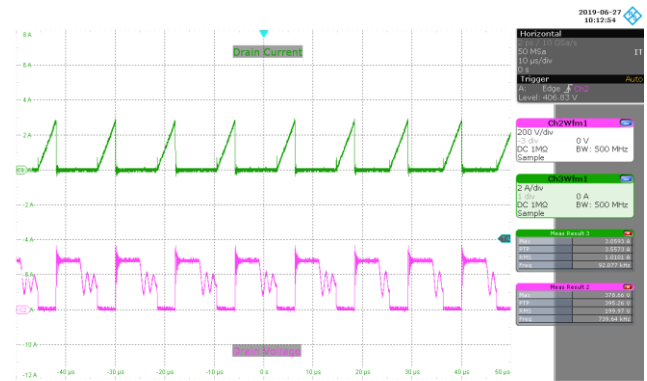

Figure 43 – 110 VAC 60 Hz, Full Load Normal.
 Upper: I_{DRAIN} , 2 A / div.
 Lower: V_{DRAIN} , 200 V / div., 10 μs / div.

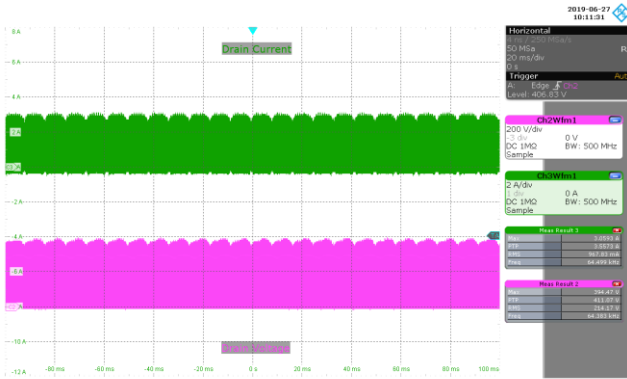

Figure 44 – 120 VAC 60 Hz, Full Load Normal.
 Upper: I_{DRAIN} , 2 A / div.
 Lower: V_{DRAIN} , 200 V / div., 20 ms / div.

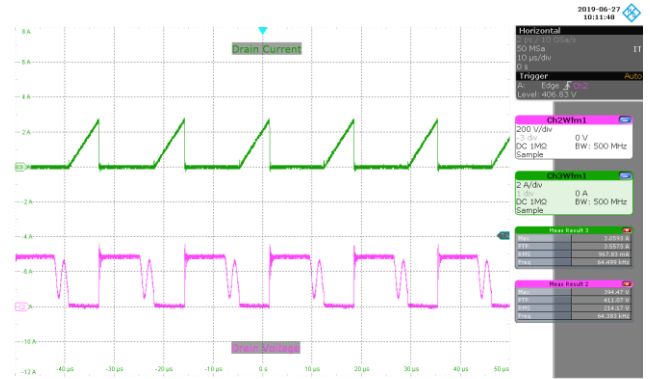

Figure 45 – 120 VAC 60 Hz, Full Load Normal.
 Upper: I_{DRAIN} , 2 A / div.
 Lower: V_{DRAIN} , 200 V / div., 10 μ s / div.

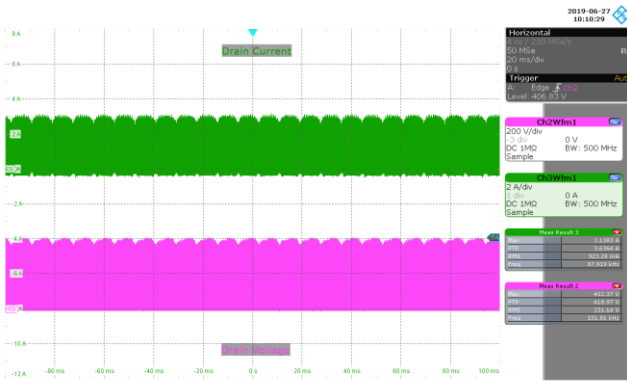

Figure 46 – 132 VAC 60 Hz, Full Load Normal.
 Upper: I_{DRAIN} , 2 A / div.
 Lower: V_{DRAIN} , 200 V / div., 20 ms / div.

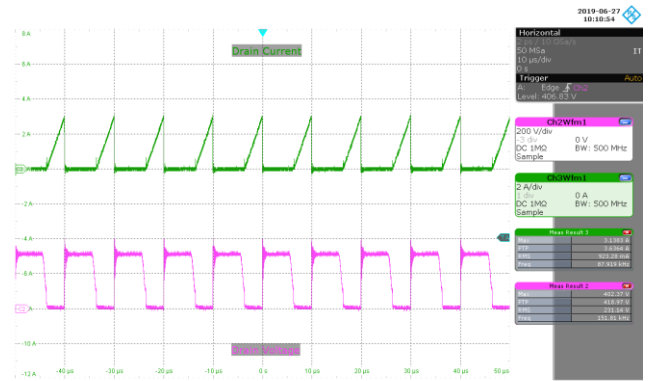

Figure 47 – 132 VAC 60 Hz, Full Load Normal.
 Upper: I_{DRAIN} , 2 A / div.
 Lower: V_{DRAIN} , 200 V / div., 10 μ s / div.

13.5 **LYTSwitch-6 Drain Voltage and Current at Full Load Start-up**

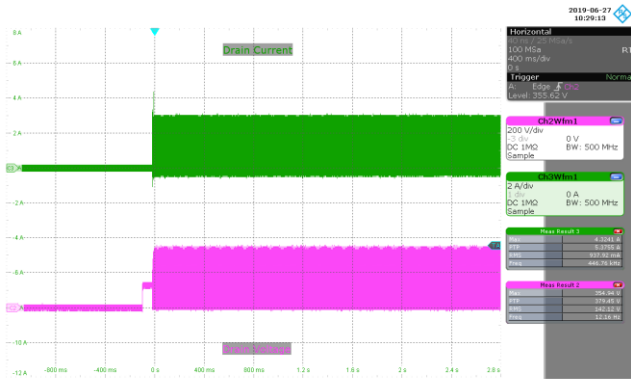

Figure 48 – 90 VAC 60 Hz, Full Load Start-up.
Upper: I_{DRAIN} , 2 A / div.
Lower: V_{DRAIN} , 200 V / div., 400 ms / div.

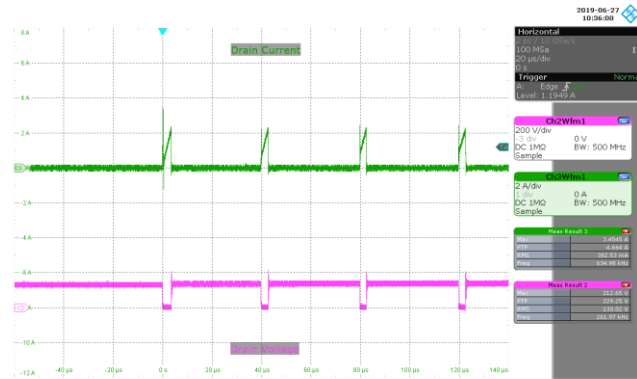

Figure 49 – 90 VAC 60 Hz, Full Load Start-up.
Upper: I_{DRAIN} , 2 A / div.
Lower: V_{DRAIN} , 200 V / div., 20 μ s / div.

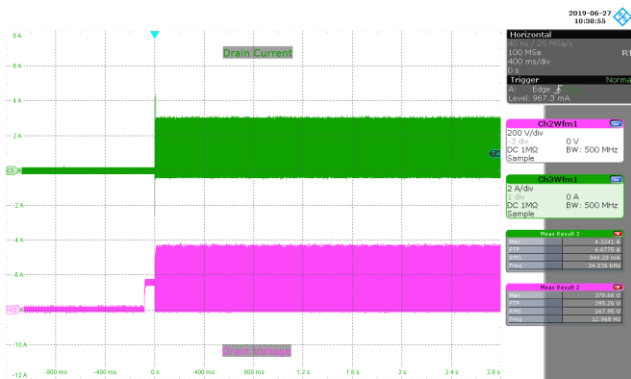

Figure 50 – 110 VAC 60 Hz, Full Load Start-up.
Upper: I_{DRAIN} , 2 A / div.
Lower: V_{DRAIN} , 200 V / div., 400 ms / div.



Figure 51 – 110 VAC 60 Hz, Full Load Start-up.
Upper: I_{DRAIN} , 2 A / div.
Lower: V_{DRAIN} , 200 V / div., 20 μ s / div.

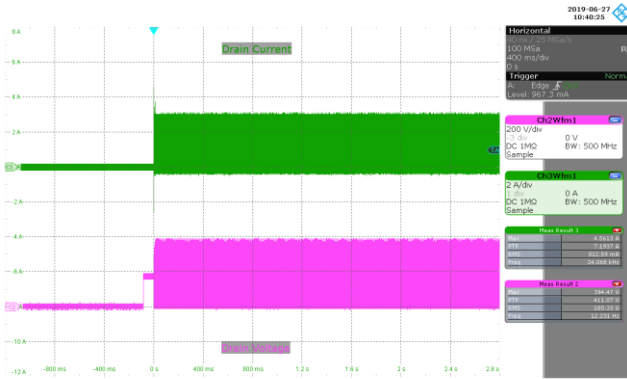

Figure 52 – 120 VAC 60 Hz, Full Load Start-up.
Upper: I_{DRAIN} , 2 A / div.
Lower: V_{DRAIN} , 200 V / div., 400 ms / div.

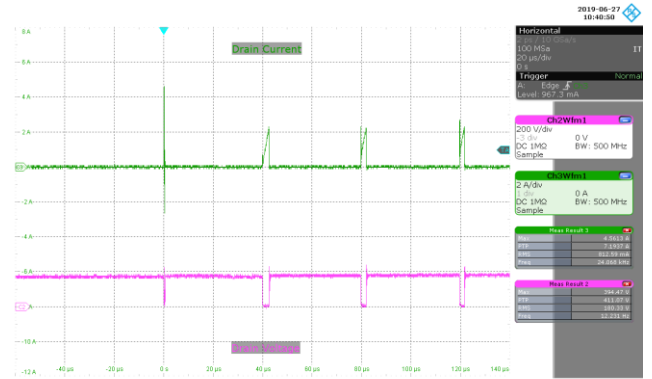

Figure 53 – 120 VAC 60 Hz, Full Load Start-up.
Upper: I_{DRAIN} , 2 A / div.
Lower: V_{DRAIN} , 200 V / div., 20 μs / div.

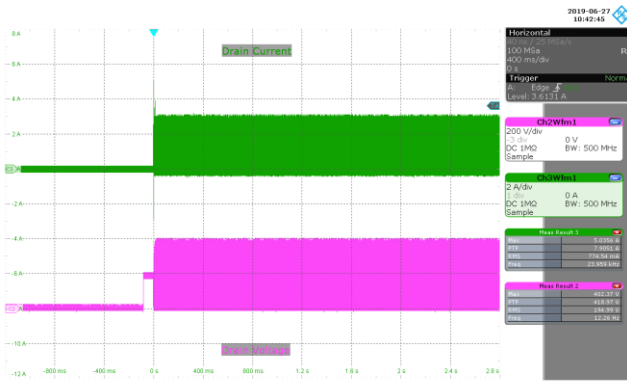

Figure 54 – 132 VAC 60 Hz, Full Load Start-up.
Upper: I_{DRAIN} , 2 A / div.
Lower: V_{DRAIN} , 200 V / div., 400 ms / div.

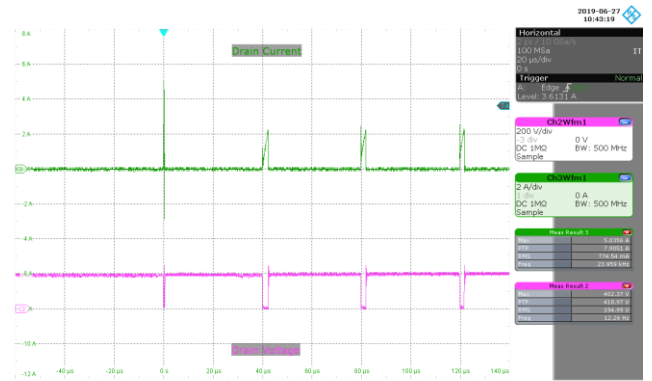

Figure 55 – 132 VAC 60 Hz, Full Load Start-up.
Upper: I_{DRAIN} , 2 A / div.
Lower: V_{DRAIN} , 200 V / div., 20 μs / div.

13.6 **LYTSwitch-6 Drain Voltage and Current during Output Short-Circuit**

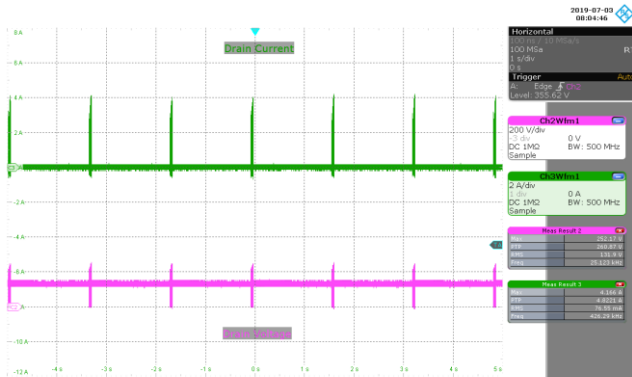

Figure 56 – 90 VAC 60 Hz, Output Shorted.
 Upper: I_{DRAIN} , 2 A / div.
 Lower: V_{DRAIN} , 200 V / div., 1 s / div.

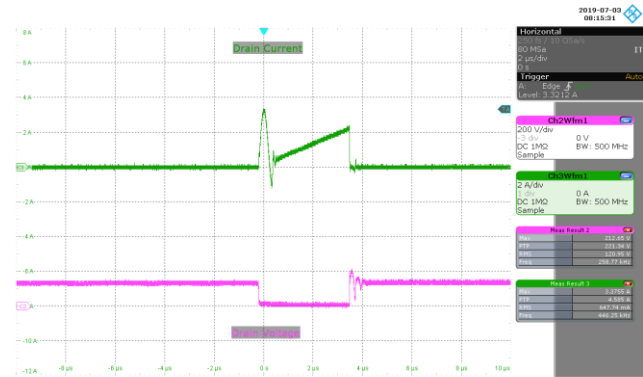

Figure 57 – 90 VAC 60 Hz, Output Shorted.
 Upper: I_{DRAIN} , 2 A / div.
 Lower: V_{DRAIN} , 200 V / div., 2 μ s / div.

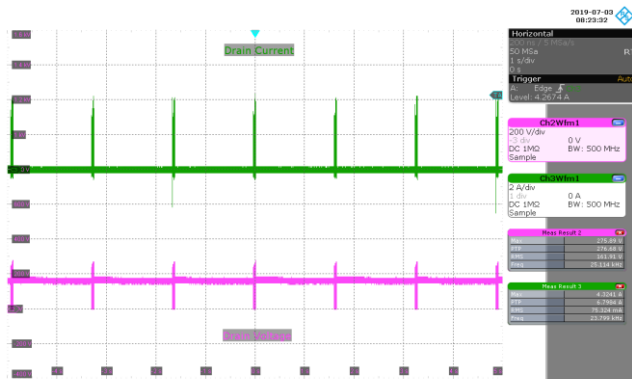

Figure 58 – 110 VAC 60 Hz, Output Shorted.
 Upper: I_{DRAIN} , 2 A / div.
 Lower: V_{DRAIN} , 200 V / div., 1 s / div.

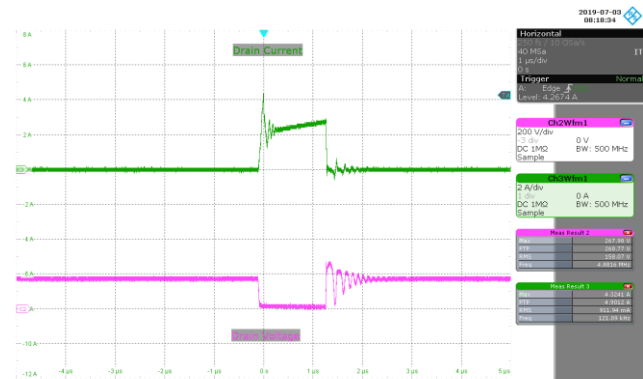

Figure 59 – 110 VAC 60 Hz, Output Shorted.
 Upper: I_{DRAIN} , 2 A / div.
 Lower: V_{DRAIN} , 200 V / div., 1 μ s / div.

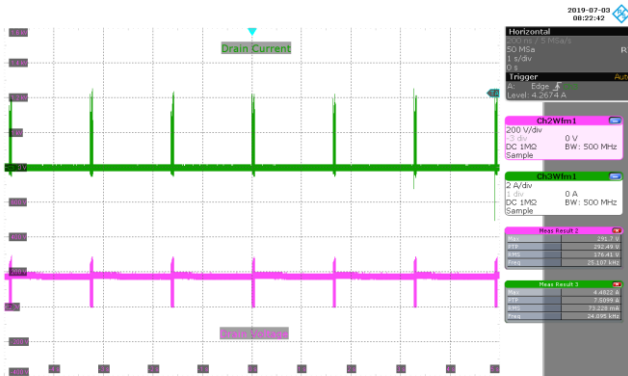

Figure 60 – 120 VAC 60 Hz, Output Shorted.
 Upper: I_{DRAIN} , 2 A / div.
 Lower: V_{DRAIN} , 200 V / div., 1 s / div.

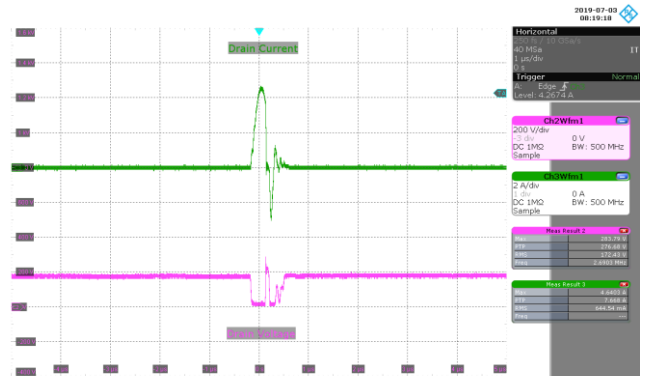

Figure 61 – 120 VAC 60 Hz, Output Shorted.
 Upper: I_{DRAIN} , 2 A / div.
 Lower: V_{DRAIN} , 200 V / div., 1 μ s / div.

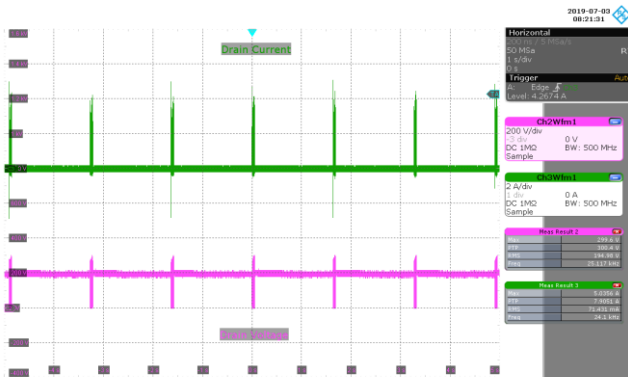

Figure 62 – 132 VAC 60 Hz, Output Shorted
 Upper: I_{DRAIN} , 2 A / div.
 Lower: V_{DRAIN} , 200 V / div., 1 s / div.

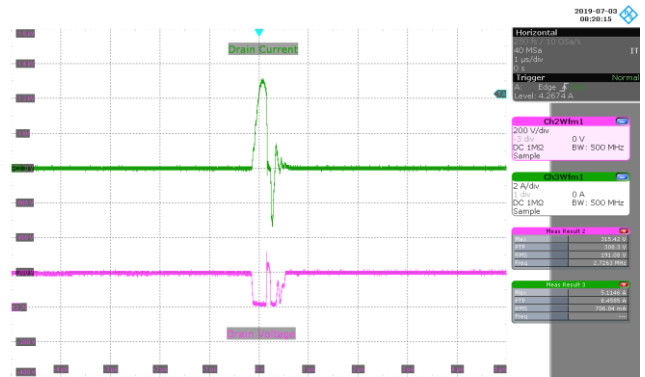

Figure 63 – 132 VAC 60 Hz, Output Shorted.
 Upper: I_{DRAIN} , 2 A / div.
 Lower: V_{DRAIN} , 200 V / div., 1 μ s / div.

13.7 ***Input Power during Output Short-Circuit***

Input				
VAC (V _{RMS})	Freq (Hz)	V _{IN} (V _{RMS})	I _{IN} (mA _{RMS})	P _{IN} (W)
90	60	89.98	53.98	0.007
100	60	100	55.27	0.008
110	60	109.93	57.22	0.008
115	60	114.97	58.14	0.009
120	60	119.94	58.94	0.010
132	60	132	60.82	0.011

13.8 PFC Diode Voltage and Current at Normal Operation

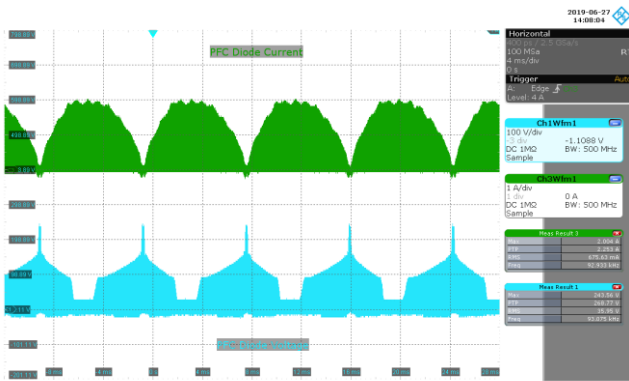

Figure 64 – 90 VAC 60 Hz, 2.7 A CC Load.
Upper: 1 A / div.
Lower: 100 V / div.
Horizontal: 4 ms / div.

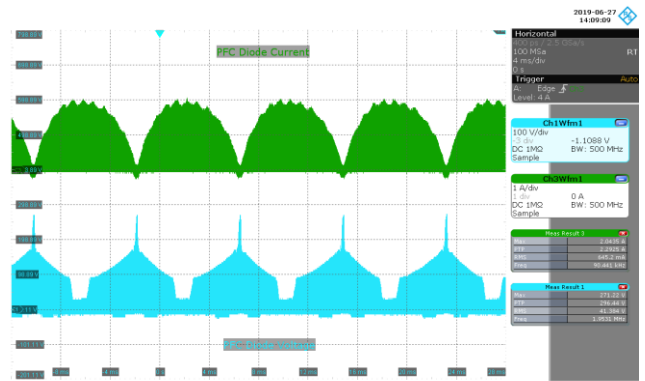

Figure 65 – 110 VAC 60 Hz, 2.7 A CC Load.
Upper: 1 A / div.
Lower: 100 V / div.
Horizontal: 4 ms / div.

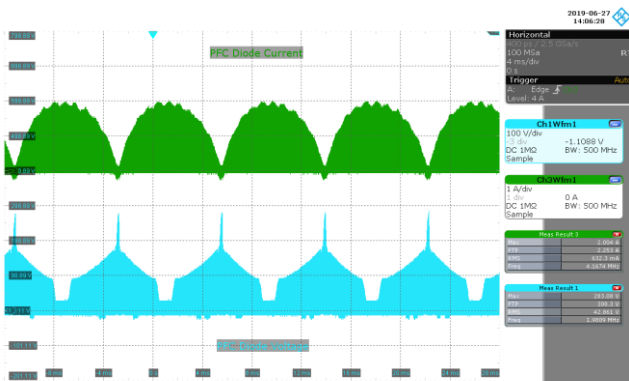

Figure 66 – 120 VAC 60 Hz, 2.7 A CC Load.
Upper: 1 A / div.
Lower: 100 V / div.
Horizontal: 4 ms / div.

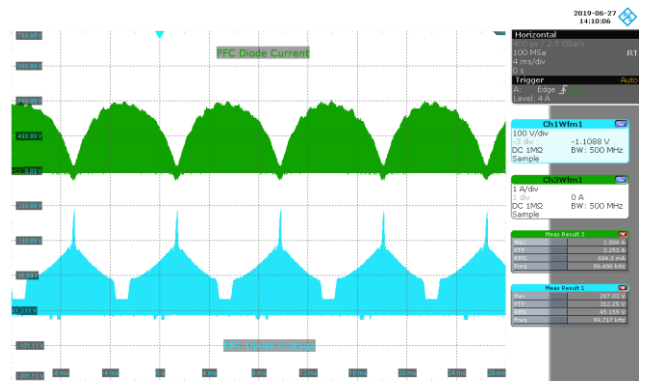

Figure 67 – 132 VAC 60 Hz, 2.7 A CC Load.
Upper: 1 A / div.
Lower: 100 V / div.
Horizontal: 4 ms / div.



13.9 **PFC Diode Voltage and Current at Start-up Full Load**

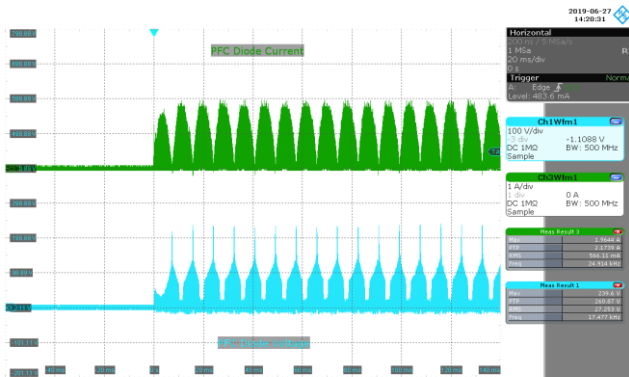

Figure 68 – 90 VAC 0 Hz, 2.7 A CC Load.
Upper: 1 A / div.
Lower: 100 V / div.
Horizontal: 20 ms / div.

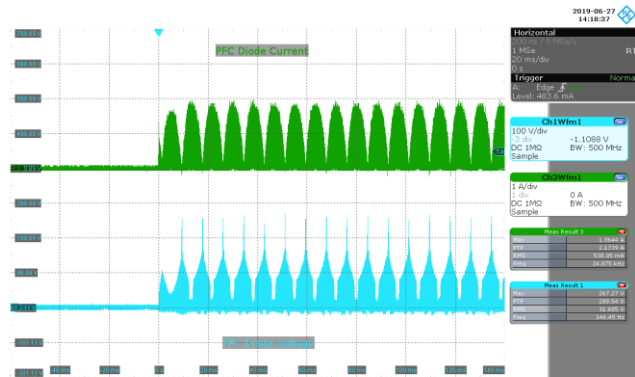

Figure 69 – 110 VAC 60 Hz, 2.7 A CC Load.
Upper: 1 A / div.
Lower: 100 V / div.
Horizontal: 20 ms / div.

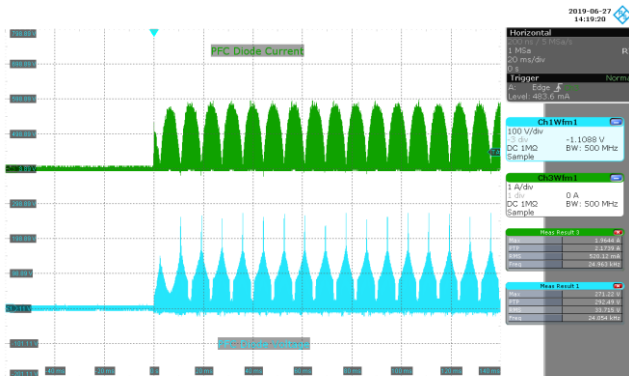

Figure 70 – 120 VAC 60 Hz, 2.7 A CC Load.
Upper: 1 A / div.
Lower: 100 V / div.
Horizontal: 20 ms / div.

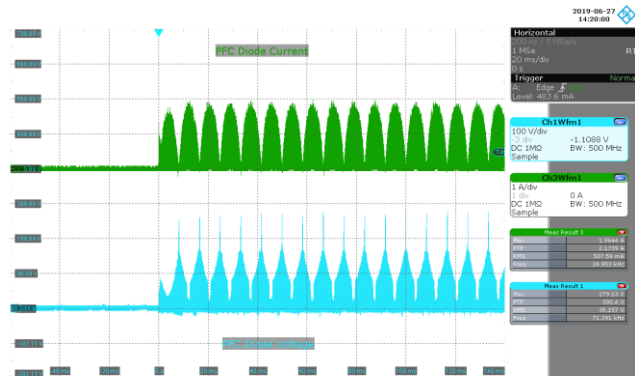

Figure 71 – 132 VAC 60 Hz, 2.7 A CC Load.
Upper: 1 A / div.
Lower: 100 V / div.
Horizontal: 20 ms / div.

13.10 **SR-FET Voltage**

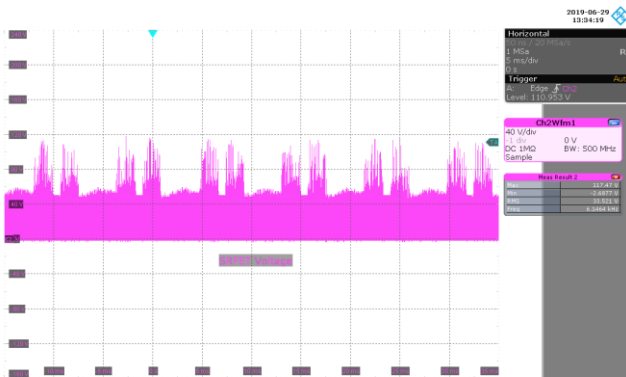

Figure 72 – 90 VAC 60 Hz, Full Load Normal.
 V_{SRFET} , 40 V / div., 5 ms / div.

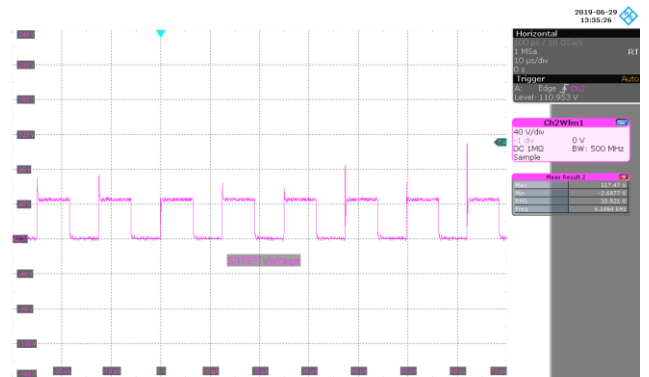

Figure 73 – 90 VAC 60 Hz, Full Load Normal.
 V_{SRFET} , 40 V / div., 10 μ s / div.

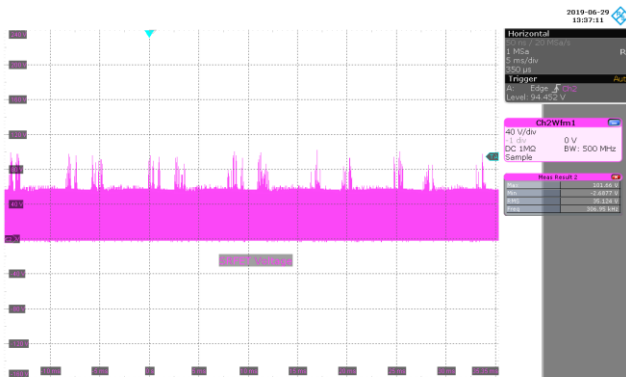

Figure 74 – 110 VAC 60 Hz, Full Load Normal.
 V_{SRFET} , 40 V / div., 5 ms / div.

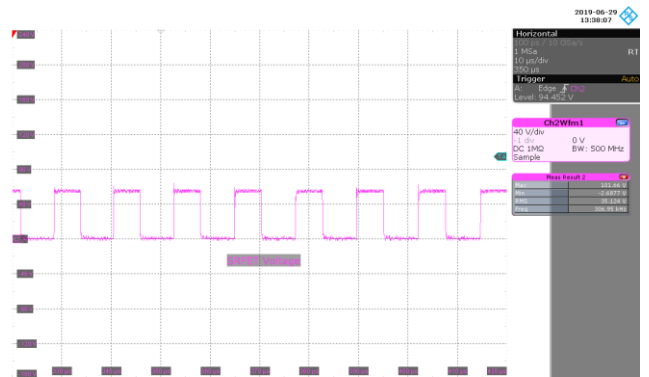

Figure 75 – 110 VAC 60 Hz, Full Load Normal.
 V_{SRFET} , 40 V / div., 10 μ s / div.



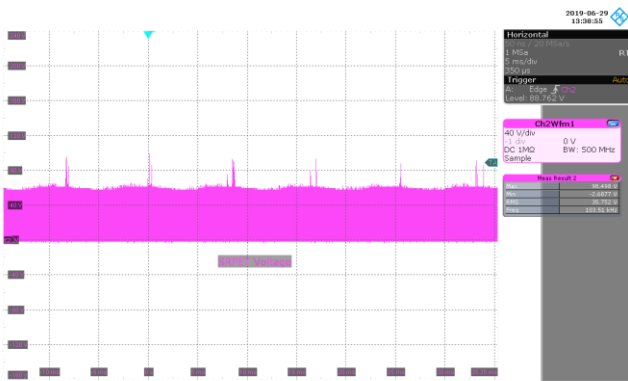

Figure 76 – 120 VAC 60 Hz, Full Load Normal.
 V_{SRFET} , 40 V / div., 5 ms / div.

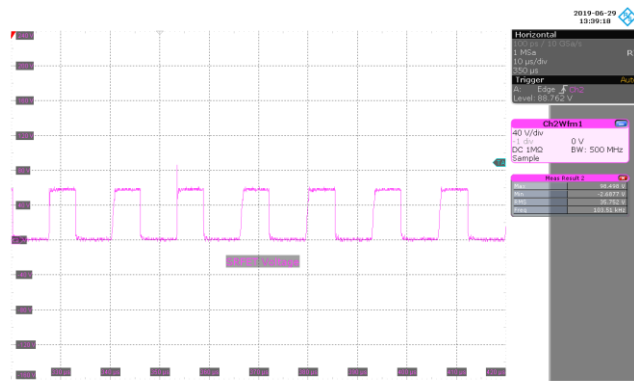

Figure 77 – 120 VAC 60 Hz, Full Load Normal.
 V_{SRFET} , 40 V / div., 10 μ s / div.

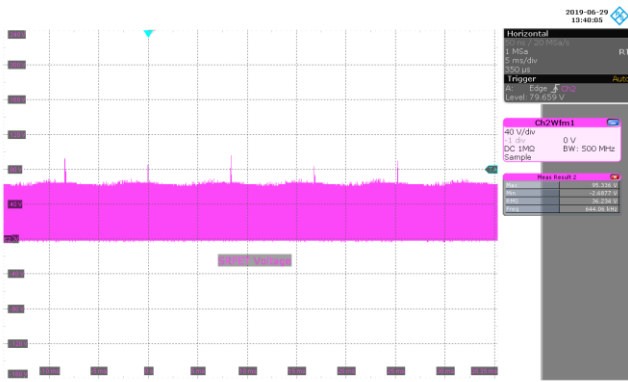

Figure 78 – 132 VAC 60 Hz, Full Load Normal.
 V_{SRFET} , 40 V / div., 5 ms / div.

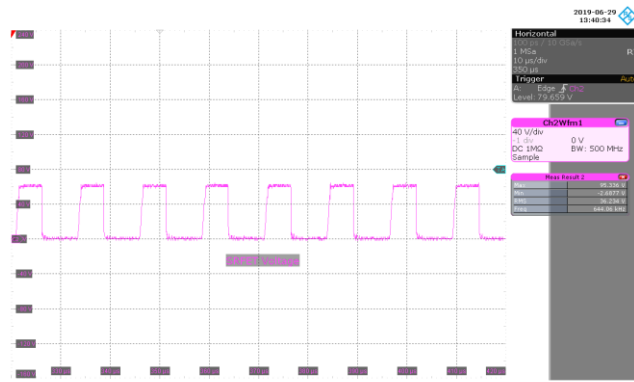

Figure 79 – 132 VAC 60 Hz, Full Load Normal.
 V_{SRFET} , 40 V / div., 10 μ s / div.

13.11 **Output Current Ripple**

13.11.1 Ripple Measurement Techniques

For DC output ripple measurements, a modified oscilloscope test probe must be utilized in order to reduce spurious signals due to pick-up. Details of the probe modification are provided in the Figures below.

The 4987BA probe adapter is affixed with two capacitors tied in parallel across the probe tip. The capacitors include one (1) 0.1 μF / 50 V ceramic type and one (1) 47 μF / 50 V aluminum electrolytic. The aluminum electrolytic type capacitor is polarized, so proper polarity across DC outputs must be maintained (see below).

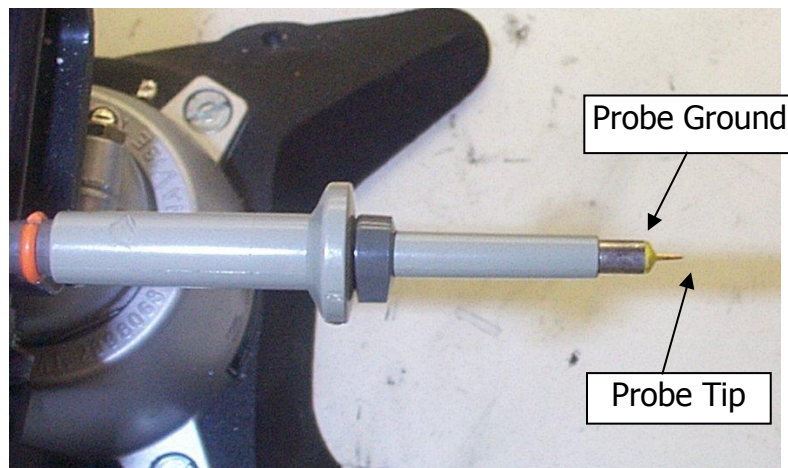

Figure 80 – Oscilloscope Probe Prepared for Ripple Measurement. (End Cap and Ground Lead Removed.)

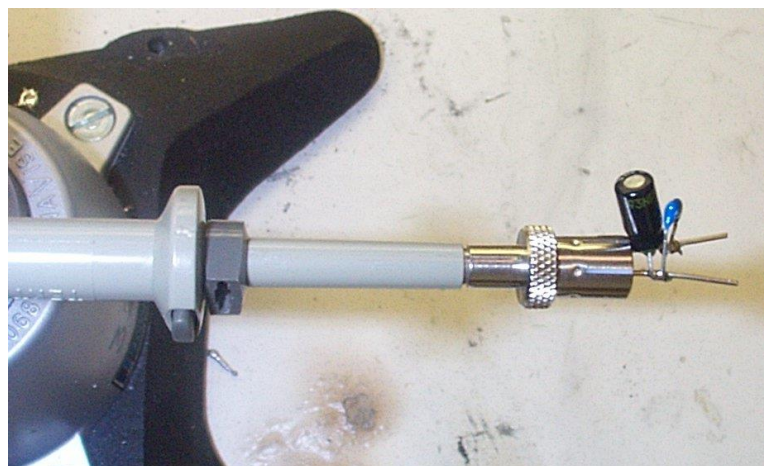

Figure 81 – Oscilloscope Probe with Probe Master (www.probemaster.com) 4987A BNC Adapter. (Modified with wires for ripple measurement, and two parallel decoupling capacitors added.)

13.11.2 Output Voltage Ripple Waveforms

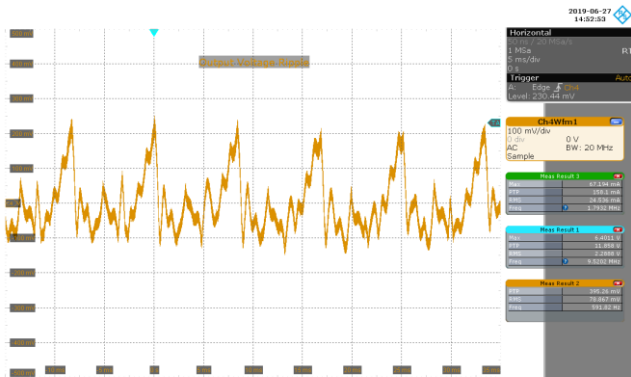

Figure 82 – 90 VAC 60 Hz, Load, Full Load Normal.
20 MHz Bandwidth.
 V_{OUT} , 100 mV / div., 5 ms / div.
Ripple Voltage: 395 mV.

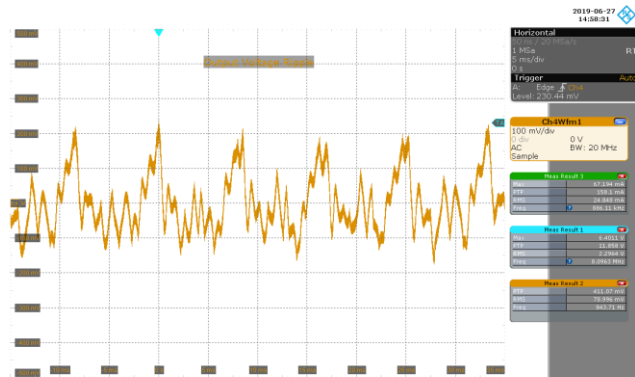

Figure 83 – 110 VAC 60 Hz, Full Load Normal
20 MHz Bandwidth.
 V_{OUT} , 100 mV / div., 5 ms / div.
Ripple Voltage: 411 mV.

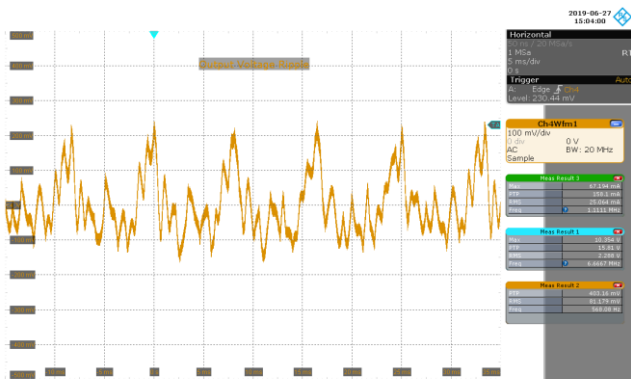

Figure 84 – 120 VAC 60 Hz, Full Load Normal.
20 MHz Bandwidth.
 V_{OUT} , 100 mV / div., 5 ms / div.
Ripple Voltage: 403 mV.

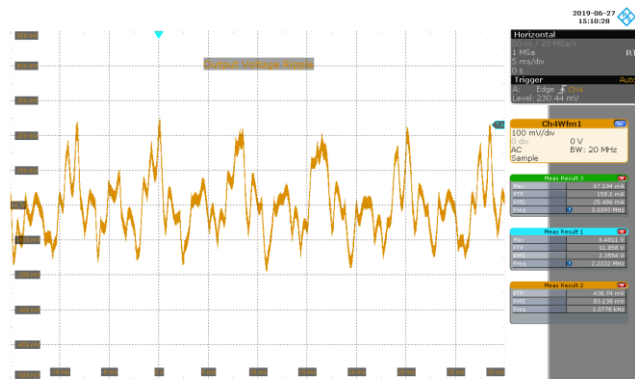

Figure 85 – 132 VAC 60 Hz, Full Load Normal.
20 MHz Bandwidth.
 V_{OUT} , 100 mV / div., 5 ms / div.
Ripple Voltage: 439 mV.

14 Conducted EMI

14.1 *Test Set-up*

14.1.1 Equipment and Load Used

1. Rohde and Schwarz ENV216 two line V-network
2. Rohde and Schwarz ESRP EMI test receiver
3. Hioki 3332 power hitester
4. Chroma Measurement Test Fixture model A662003
5. 9 Ω Resistor Load
6. HOSSONI TDGC2 VARIAC set at 120 VAC 60 Hz

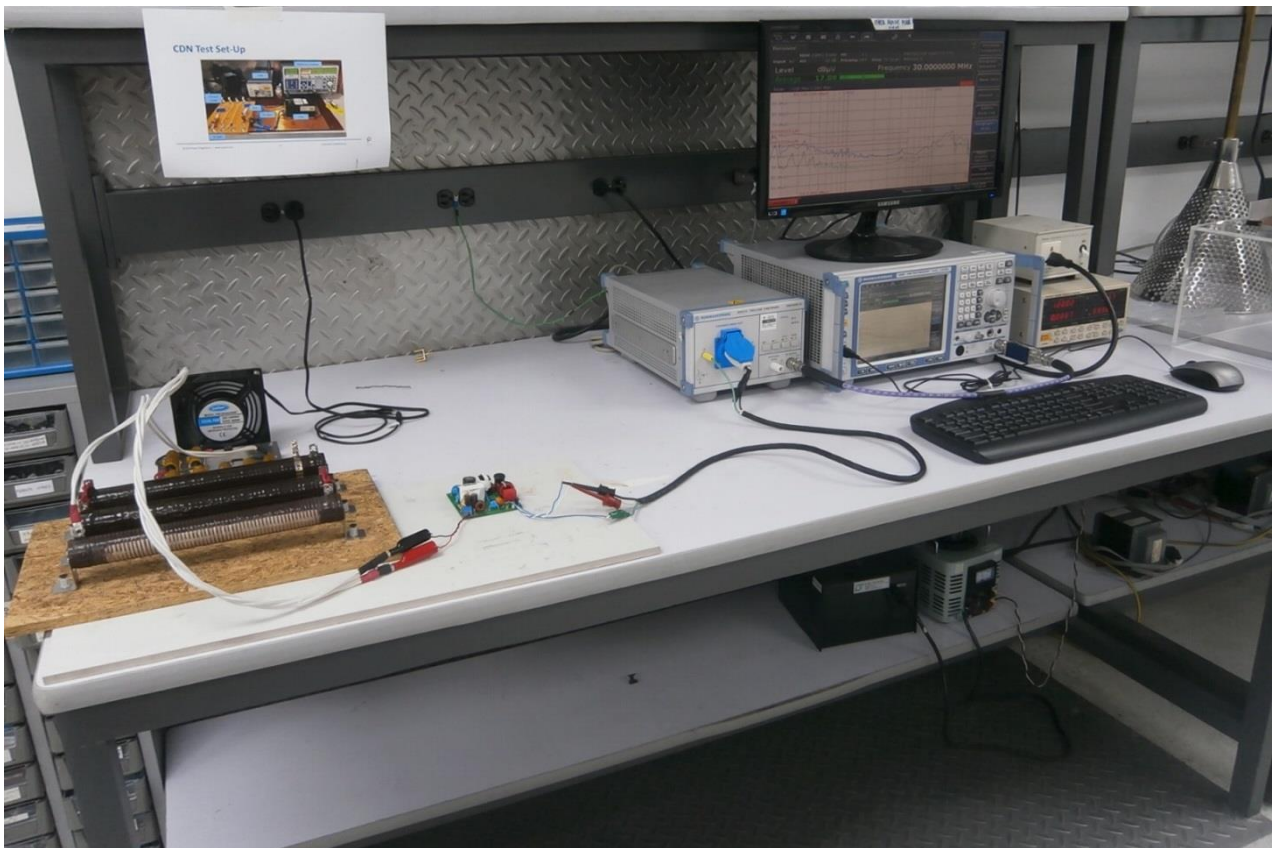
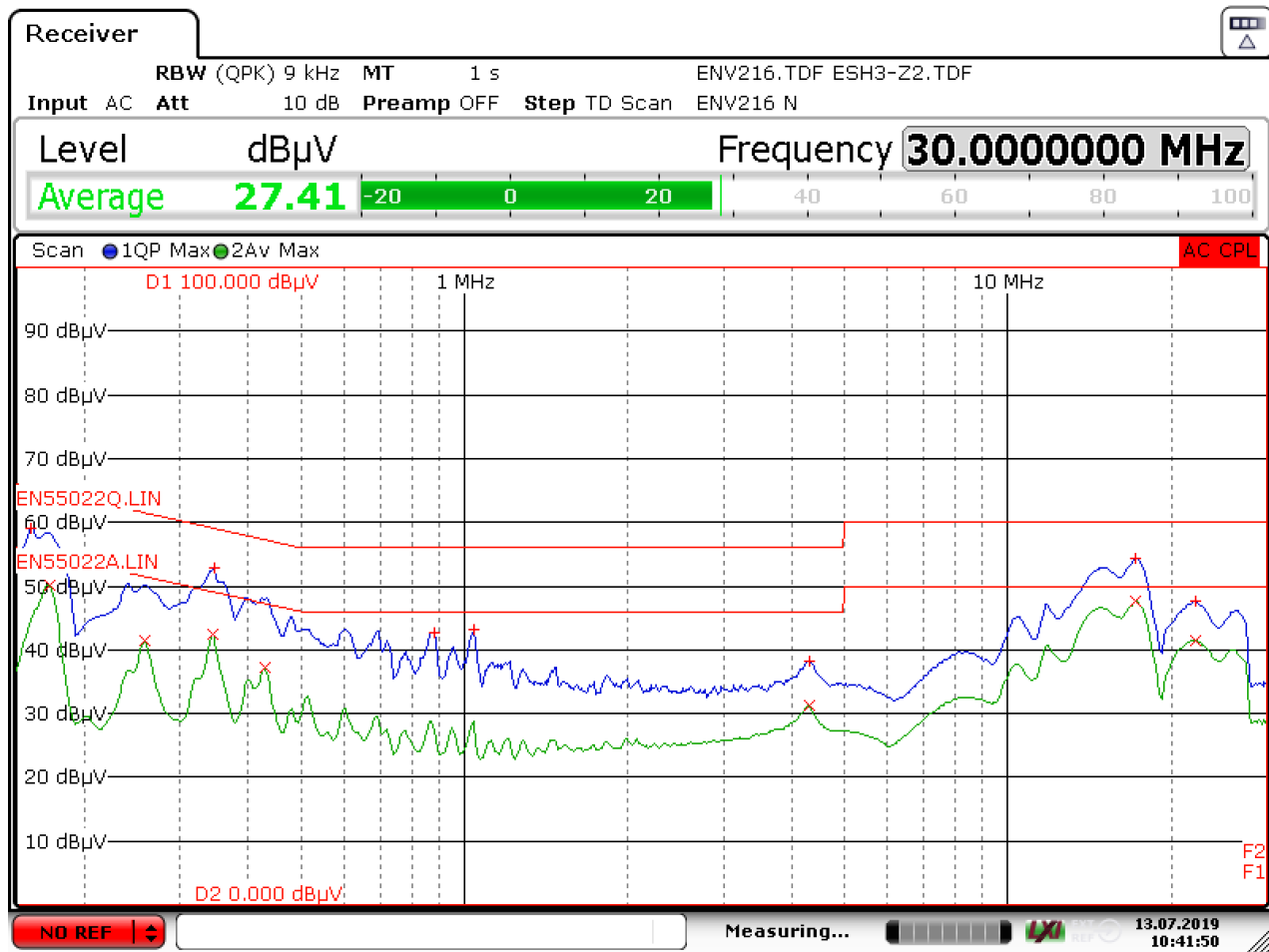

Figure 86 — Conducted EMI Test Set-up.

14.2 EMI Test Result

14.2.1 Earthed Conducted EMI



Date: 13.JUL.2019 10:41:51

Figure 87 – Conducted EMI QP Scan at Full Load, Earthed, 120 VAC 60 Hz and EN55022 B Limits.

Trace/Detector	Frequency	Level dB μ V	DeltaLimit
2 Average	17.1735 MHz	47.54 L1	-2.46 dB
2 Average	172.5000 kHz	50.09 N	-4.75 dB
1 Quasi Peak	17.2455 MHz	54.29 L1	-5.71 dB
1 Quasi Peak	345.7500 kHz	52.94 L1	-6.12 dB
1 Quasi Peak	159.0000 kHz	58.99 N	-6.53 dB
2 Average	343.5000 kHz	42.31 N	-6.81 dB
2 Average	22.1168 MHz	41.43 N	-8.57 dB
2 Average	429.0000 kHz	37.21 L1	-10.06 dB
2 Average	258.0000 kHz	41.37 N	-10.13 dB
1 Quasi Peak	22.1213 MHz	47.54 N	-12.46 dB
1 Quasi Peak	1.0410 MHz	43.08 L1	-12.92 dB
1 Quasi Peak	879.0000 kHz	42.70 L1	-13.30 dB
2 Average	4.3215 MHz	31.32 L1	-14.68 dB
1 Quasi Peak	4.3260 MHz	38.32 L1	-17.68 dB

Figure 88 – Conducted EMI Data at 120 VAC 60 Hz, Full Load Earthed.

15 Line Surge

The unit was subjected to ± 2500 V ring wave and ± 1000 V differential surge with 10 strikes for each condition. The test is considered a failure in case of non-recoverable interruption of output that requires either repair or AC recycling.

15.1 Differential Surge Test Results

Surge Level (V)	Input Voltage (VAC)	Injection Location	Injection Phase	Line Impedance (Ω)	Test Result (Pass/Fail)
+1000	115	L to N	0	2	Pass
+1000	115	L to N	90	2	Pass
+1000	115	L to N	270	2	Pass
-1000	115	L to N	0	2	Pass
-1000	115	L to N	90	2	Pass
-1000	115	L to N	270	2	Pass
+1000	230	L to N	0	2	Pass
+1000	230	L to N	90	2	Pass
+1000	230	L to N	270	2	Pass
-1000	230	L to N	0	2	Pass
-1000	230	L to N	90	2	Pass
-1000	230	L to N	270	2	Pass

15.2 Ring Wave Surge Test Results

Surge Level (V)	Input Voltage	Injection Location	Injection Phase	Line Impedance (Ω)	Test Result (Pass/Fail)
+2500	115	L to N	0	12	Pass
+2500	115	L to N	90	12	Pass
+2500	115	L to N	270	12	Pass
-2500	115	L to N	0	12	Pass
-2500	115	L to N	90	12	Pass
-2500	115	L to N	270	12	Pass
+2500	230	L to N	0	12	Pass
+2500	230	L to N	90	12	Pass
+2500	230	L to N	270	12	Pass
-2500	230	L to N	0	12	Pass
-2500	230	L to N	90	12	Pass
-2500	230	L to N	270	12	Pass

16 Revision History

Date	Author	Revision	Description and Changes	Reviewed
11-Nov-19	JB	1.0	Initial Release.	Apps



For the latest updates, visit our website: www.power.com

Reference Designs are technical proposals concerning how to use Power Integrations' gate drivers in particular applications and/or with certain power modules. These proposals are "as is" and are not subject to any qualification process. The suitability, implementation and qualification are the sole responsibility of the end user. The statements, technical information and recommendations contained herein are believed to be accurate as of the date hereof. All parameters, numbers, values and other technical data included in the technical information were calculated and determined to our best knowledge in accordance with the relevant technical norms (if any). They may be based on assumptions or operational conditions that do not necessarily apply in general. We exclude any representation or warranty, express or implied, in relation to the accuracy or completeness of the statements, technical information and recommendations contained herein. No responsibility is accepted for the accuracy or sufficiency of any of the statements, technical information, recommendations or opinions communicated and any liability for any direct, indirect or consequential loss or damage suffered by any person arising therefrom is expressly disclaimed.

Power Integrations reserves the right to make changes to its products at any time to improve reliability or manufacturability. Power Integrations does not assume any liability arising from the use of any device or circuit described herein. POWER INTEGRATIONS MAKES NO WARRANTY HEREIN AND SPECIFICALLY DISCLAIMS ALL WARRANTIES INCLUDING, WITHOUT LIMITATION, THE IMPLIED WARRANTIES OF MERCHANTABILITY, FITNESS FOR A PARTICULAR PURPOSE, AND NON-INFRINGEMENT OF THIRD PARTY RIGHTS.

Patent Information

The products and applications illustrated herein (including transformer construction and circuits' external to the products) may be covered by one or more U.S. and foreign patents, or potentially by pending U.S. and foreign patent applications assigned to Power Integrations. A complete list of Power Integrations' patents may be found at www.power.com. Power Integrations grants its customers a license under certain patent rights as set forth at <http://www.power.com/ip.htm>.

Power Integrations, the Power Integrations logo, CAPZero, ChiPhy, CHY, DPA-Switch, EcoSmart, E-Shield, eSIP, eSOP, HiperPLC, HiperPFS, HiperTFS, InnoSwitch, Innovation in Power Conversion, InSOP, LinkSwitch, LinkZero, LYTSwitch, SENZero, TinySwitch, TOPSwitch, PI, PI Expert, SCALE, SCALE-1, SCALE-2, SCALE-3 and SCALE-iDriver, are trademarks of Power Integrations, Inc. Other trademarks are property of their respective companies. ©2019, Power Integrations, Inc.

Power Integrations Worldwide Sales Support Locations**WORLD HEADQUARTERS**

5245 Hellyer Avenue
San Jose, CA 95138, USA.
Main: +1-408-414-9200
Customer Service:
Worldwide: +1-65-635-64480
Americas: +1-408-414-9621
e-mail: usasales@power.com

CHINA (SHANGHAI)

Rm 2410, Charity Plaza, No. 88,
North Caoxi Road,
Shanghai, PRC 200030
Phone: +86-21-6354-6323
e-mail: chinasales@power.com

CHINA (SHENZHEN)

17/F, Hivac Building, No. 2, Keji
Nan 8th Road, Nanshan District,
Shenzhen, China, 518057
Phone: +86-755-8672-8689
e-mail: chinasales@power.com

GERMANY (AC-DC/LED Sales)

Einsteinring 24
85609 Dornach/Aschheim
Germany
Tel: +49-89-5527-39100
e-mail: eurosales@power.com

GERMANY (Gate Driver Sales)

HellwegForum 1
59469 Ense
Germany
Tel: +49-2938-64-39990
e-mail: igbt-driver.sales@power.com

INDIA

#1, 14th Main Road
Vasanthanagar
Bangalore-560052
India
Phone: +91-80-4113-8020
e-mail: indiasales@power.com

ITALY

Via Milanese 20, 3rd. Fl.
20099 Sesto San Giovanni (MI) Italy
Phone: +39-024-550-8701
e-mail: eurosales@power.com

JAPAN

Yusen Shin-Yokohama 1-chome Bldg.
1-7-9, Shin-Yokohama, Kohoku-ku
Yokohama-shi,
Kanagawa 222-0033 Japan
Phone: +81-45-471-1021
e-mail: japansales@power.com

KOREA

RM 602, 6FL
Korea City Air Terminal B/D,
159-6
Samsung-Dong, Kangnam-Gu,
Seoul, 135-728 Korea
Phone: +82-2-2016-6610
e-mail: koreasales@power.com

SINGAPORE

51 Newton Road,
#19-01/05 Goldhill Plaza
Singapore, 308900
Phone: +65-6358-2160
e-mail: singaporesales@power.com

TAIWAN

5F, No. 318, Nei Hu Rd.,
Sec. 1
Nei Hu District
Taipei 11493, Taiwan R.O.C.
Phone: +886-2-2659-4570
e-mail: taiwansales@power.com

UK

Building 5, Suite 21
The Westbrook Centre
Milton Road
Cambridge
CB4 1YG
Phone: +44 (0) 7823-557484
e-mail: eurosales@power.com

